

EN AIDOO PRO HUB TOSHIBA DOMESTIC

Read before installation.

Device for remote control and integration of HVAC systems through the "Airzone Cloud" app. Dual-band Wi-Fi connection (2.4/5 GHz) or Ethernet. External power supply at 110 / 230 Vac.

Features:

- Error detection for connected units.
- Open window and occupancy detection.
- Auxiliary heat source control and lockout.
- Combined control of air and radiant heating stages.
- Automatic mode switching with two configurable set-point temperatures.
- Temperature limitation for cooling and heating modes.
- Time schedules.
- Cloud and/or wired integration with third-party smart thermostats.
- Integration via Modbus TCP/IP and RTU, BACnet IP and MS-TP, Airzone or Lutron Palladiom thermostats.
- Local API, Cloud API, and multicast mDNS integration services.

ES AIDOO PRO HUB TOSHIBA DOMESTIC

Leer antes de instalar.

Dispositivo para el control e integración remotos de equipos de climatización a través de la App "Airzone Cloud". Conexión a red vía Wi-Fi Dual (2.4/5 GHz) o Ethernet. Alimentación externa a 110 / 230 Vac.

Funcionalidades:

- Detección de errores de la unidad.
- Detección de ventana abierta o presencia.
- Control y bloqueo de fuentes de calor auxiliares.
- Control combinado de etapas de calor de aire y radiante.
- Cambio de modo automático con dos temperaturas de consigna configurables.
- Limitación de temperaturas para modos frío y calor.
- Programaciones horarias.
- Integración Cloud y/o cableada con termostatos inteligentes de terceros.
- Integración mediante Modbus TCP/IP y RTU, BACnet IP y MS-TP, termostatos Airzone o Lutron Palladiom.
- Servicios de integración API local, API Cloud y multicast mDNS.

FR AIDOO PRO HUB TOSHIBA DOMESTIC

Lire avant installation.

Dispositif pour le contrôle et l'intégration à distance d'unités de chauffage et refroidissement grâce à l'application « Airzone Cloud ». Connexion au réseau par Wi-Fi Double (2,4/5 GHz) ou Ethernet. Alimentation externe 110 / 230 Vac.

Fonctionnalités :

- Détection des erreurs de l'unité.
- Détection de fenêtre ouverte ou de présence.
- Contrôle et blocage des sources de chaleur auxiliaires.
- Contrôle combiné des étapes de chaleur d'air et par rayonnement.
- Changement de mode automatique avec deux températures de consigne configurables.
- Limitation des températures pour les modes refroidissement et chauffage.
- Programmations horaires.
- Intégration dans le cloud et/ou câblée avec des thermostats intelligents de tiers.
- Intégration via Modbus TCP/IP et RTU, BACnet IP et MS-TP, thermostats Airzone ou Lutron Palladiom.
- Services d'intégration API local, API Cloud et multicast mDNS.

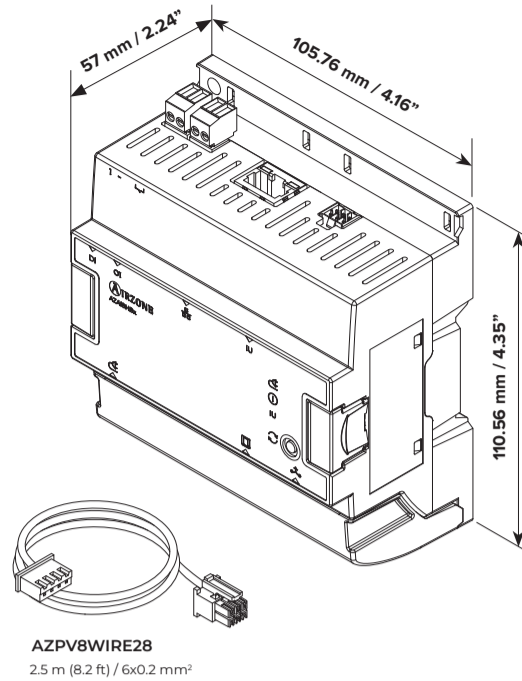

(EN) TECHNICAL SPECS (ES) CARACTERÍSTICAS TÉCNICAS (FR) CARACTÉRISTIQUES TECHNIQUES

Power supply / Alimentación / Alimentation	
V max	110 - 230 Vac
I max	250 mA
Frequency / Frecuencia / Fréquence	60 / 50 Hz
Stand-by consumption / Consumo Stand-by / Consommation Stand-by	3.4 W (110 Vac) 4.3 W (230 Vac)
Airzone bus / Bus Airzone / Bus Airzone	
Integrations bus / Bus Integraciones / Bus Intégrations	
Shielded twisted pair / Cable apantallado y trenzado / Câble torsadé et blindé	2 x 0.22 + 2 x 0.5 mm ² (AWG 24 - 2 wired + AWG 20 - 2 wired) 2 x 0.22 + 1 x 0.5 mm ² (AWG 24 - 2 wired + AWG 20 - 1 wired) Min: 0.2 mm ² / Max: 1.5 mm ²
Communications protocol / Protocolo de comunicaciones / Protocole de communication	RS-485 BACnet MS-TP Par - 19200 bps
DI - Digital input / Entrada digital / Entrée numérique	
Voltage-free / Libre de tensión / Libre de tension	
Max. distance / Distancia máx. / Distance max.	10 m (32.8 ft)
O1 - Relay output / Salida de relé / Sortie relais	
Voltage-free / Libre de tensión / Libre de tension	
V max (I max)	230 Vac (5A) 30 Vdc (3A)
Ethernet	
Type of cable / Tipo de Cable / Type de câble	Min. UTP CAT 5
Standard / Norma / Norme	100BASE-TX
IP address / Dirección IP / Adressage IP	DHCP
IU - Connection to indoor unit / Conexión con unidad interior / Connexion avec l'unité intérieure	
Max. distance / Distancia máx. / Distance max.	10 m (32.8 ft)
Wi-Fi	
Protocol / Protocolo / Protocole	802.11a/b/g/n/ac (802.11n up to 150 Mbps)
Model / Modelo / Modèle	LBEE5HY1MW
Communication frequency / Frecuencia de comunicación / Fréquence de communication	2.4 GHz (max. 150 Mbps) 5 GHz (max. 433 Mbps)
Max. power, Antenna power / Potencia máx., Potencia antena / Force max., Force de l'antenne	17.93 dBm, 0.1 dBi
Sensitivity / Sensibilidad / Sensibilité	- 82 dBm
IP address / Dirección IP / Adressage IP	DHCP
Bluetooth	
Protocol / Protocolo / Protocole	Bluetooth v5.0 BLE specification
Max. power, Antenna power / Potencia máx., Potencia antena / Force max., Force de l'antenne	5.46 dBm, 0.1 dBi
Operating temp. / Temp. operativas / Temp. opérative	
Storage / Almacenaje / De stockage	- 20 ... 70 °C (- 4 ... 158 °F)
Operation / Funcionamiento / De fonctionnement	0 ... 45 °C (32 ... 113 °F)
Operating humidity range / Rango de humedad de funcionamiento / Plage d'humidité de fonctionnement	5 ... 90 % (non-condensing)
Mechanical aspects / Aspectos mecánicos / Aspects mécaniques	
Protection class / Grado de protección / Degré de protection	IP 20
Weight / Peso / Poids	210 g (0.46 lb)
In DIN units / Unidades DIN / En unités DIN	6
Max. operating height / Altura máx. de funcionamiento / Hauteur max. fonctionnement	2000 m (6561.68 ft)

FCC / ISED

This device complies with Part 15 of the FCC Rules and Industry Canada licence-exempt RSS standard(s). Operation is subject to the following two conditions: (1) this device may not cause interference, and (2) this device must accept any interference, including interference that may cause undesired operation of the device. Corporacion Empresarial Altra S.L. has not approved any changes or modifications to this device by the user. Any changes or modifications could void the user's authority to operate the equipment. This equipment has been tested and found to comply with the limits for a Class B digital device, pursuant to part 15 of the FCC Rules. These limits are designed to provide reasonable protection against harmful interference in a residential installation. This equipment generates, uses and can radiate radio frequency energy and, if not installed and used in accordance with the instructions, may cause harmful interference to radio communications. However, there is no guarantee that interference will not occur in a particular installation. If this equipment does cause harmful interference to radio or television reception, which can be determined by turning the equipment off and on, the user is encouraged to try to correct the interference by one or more of the following measures:

- Reorient or relocate the receiving antenna.
- Increase the separation between the equipment and receiver.
- Connect the equipment into an outlet on a circuit different from that to which the receiver is connected.
- Consult the dealer or an experienced radio/TV technician for help.

This Class B digital apparatus complies with Canadian ICES-003. / Cet appareil numérique de classe B est conforme à la norme canadienne NMB-003.

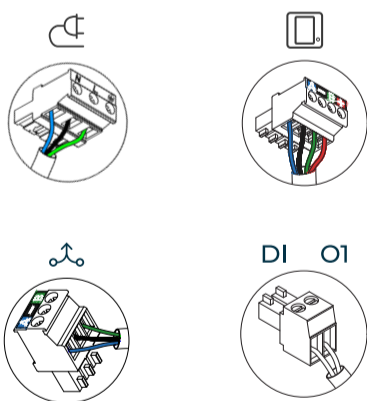

N Neutral | Neutro | Neutre
L Phase | Fase | Phase
G Ground | Tierra | Terre

A Blue | Azul | Bleu
- Black | Negro | Noir
B Green | Verde | Vert
+ Red | Rojo | Rouge

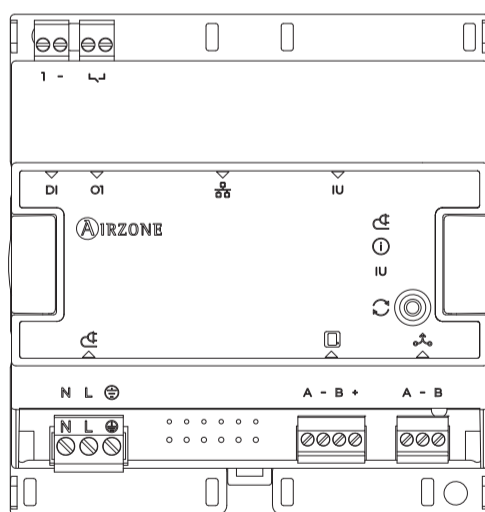

airzonecontrol.com

Marie Curie, 21
29590 Málaga, Spain





(EN) ASSEMBLY AND CONNECTION / (ES) MONTAJE Y CONEXIÓN / (FR) MONTAGE ET CONNEXION



Installation requirements:

- This equipment is not suitable for use in locations where children are likely to be present.
- It is necessary to mount this device into a CSA Certified / UL Listed electric enclosure.
- In case of performing the LEAP integration through a Wi-Fi connection, it is recommended that the CSA Certified / UL Listed electric enclosure used be made of ABS, polycarbonate, or glass-fiber-reinforced polyester.
- Protective earthing of the equipment shall be connected to the protective earthing conductor of the building installation.
- An external all-pole mains switch in accordance with Annex L of IEC 62368-1 shall be provided as part of the final installation.



Requisitos de instalación:

- Este equipo no es adecuado para su uso en lugares donde sea probable la presencia de niños.
- Es necesario montar este dispositivo en una caja eléctrica certificada por CSA / UL.
- En caso de realizar la integración de LEAP a través de una conexión Wi-Fi, se recomienda que la caja eléctrica certificada CSA / UL utilizada esté fabricada en ABS, polycarbonato o poliéster reforzado con fibra de vidrio.
- La puesta a tierra de protección del equipo debe conectarse al conductor de puesta a tierra de protección de la instalación del edificio.
- Como parte de la instalación final, debe incorporarse un interruptor de red externo omnipolar conforme al Anexo L de la norma IEC 62368-1.



Exigences d'installation:

- Cet équipement ne convient pas à une utilisation dans des lieux où des enfants sont susceptibles d'être présents.
- Pour le montage, il est nécessaire d'utiliser un boîtier électrique certifié.
- Si l'intégration LEAP est effectuée via une connexion Wi-Fi, il est recommandé que le boîtier électrique homologué CSA / UL soit fabriqué en ABS, en polycarbonate ou en polyester renforcé de fibre de verre.
- La mise à la terre de protection de l'équipement doit être raccordée au conducteur de mise à la terre de protection de l'installation du bâtiment.
- Un interrupteur secteur externe omnipolaire conforme à l'Annexe L de la norme IEC 62368-1 doit être prévu dans le cadre de l'installation finale.

(EN) **Important:** It is recommended to maintain an alternative control of the unit for situations in which connection to the network is lost.

(ES) **Importante:** Se recomienda mantener un control alternativo de la unidad para situaciones de pérdida de conexión a la red.

(FR) **Attention :** Il est recommandé de prévoir un autre moyen de contrôle de l'unité en cas de perte de connexion au réseau.

1



2

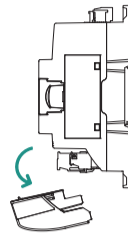

3

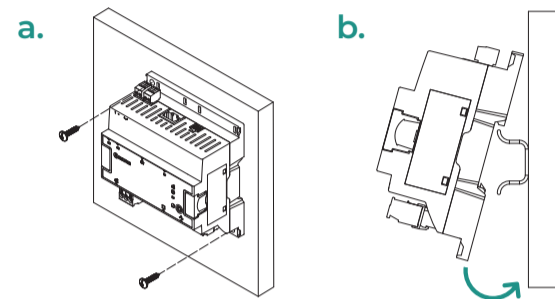

4

AZAI6BLUEZEROC[B/N]

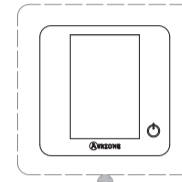

Modbus RTU
BACnet MS-TP
Lutron Palladiom

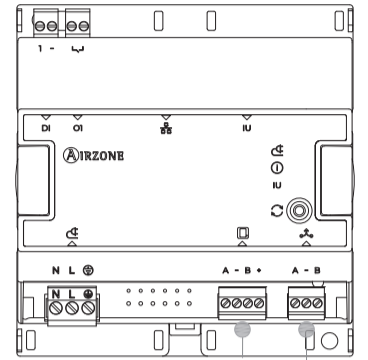

5

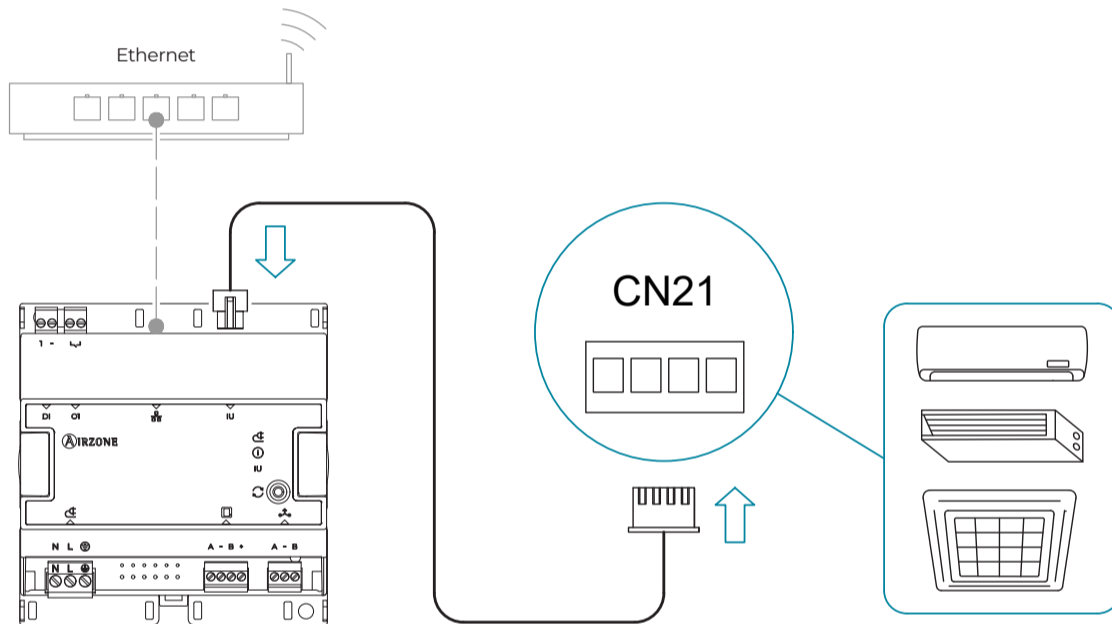

6

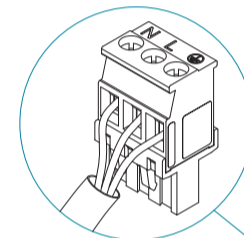

110/230 VAC

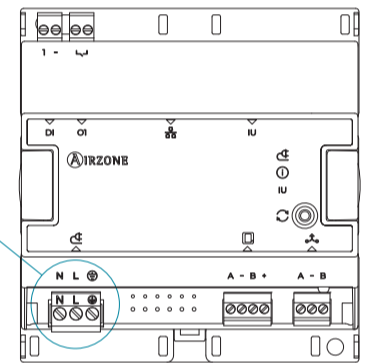

N Neutral | Neutro | Neutre
L Phase | Fase | Phase
Ground | Tierra | Terre

7

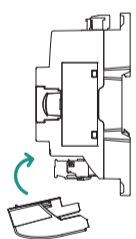

8

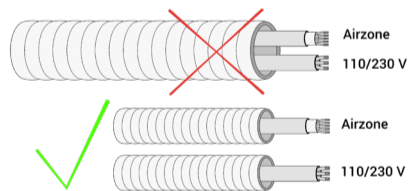
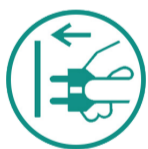

9



10



App Airzone Cloud



(EN) INFORMATION / (ES) INFORMACIÓN / (FR) INFORMATION

	Power supply / Alimentación / Alimentation
	Device state / Estado del dispositivo / État du dispositif
	Communication to indoor unit / Comunicación con la unidad interior / Communication avec l'unité intérieure
	Reboot or reset / Reinicio o reseteo / Réinitialisation ou restauration

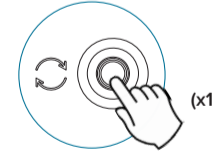
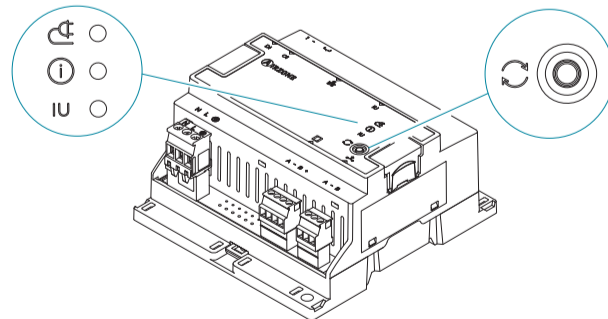

(EN) Device reboot
(ES) Reinicio del dispositivo
(FR) Réinitialisation du dispositif

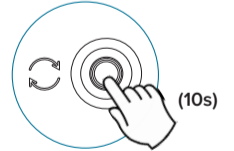

(EN) Factory reset
(ES) Reset a valores de fábrica
(FR) Restaurer les paramètres d'usine