



EN

Installation Manual

Easyzone 25 Plus Compact Wi-Fi / HUB



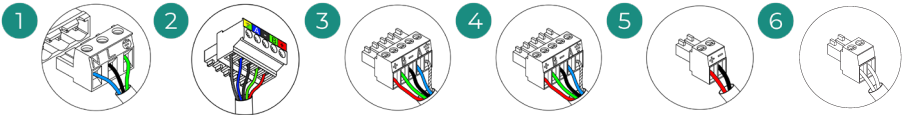
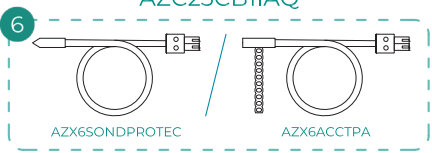
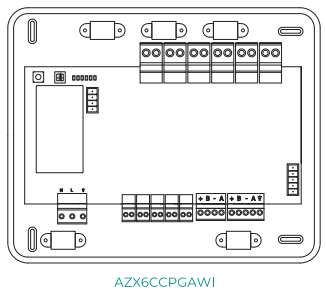
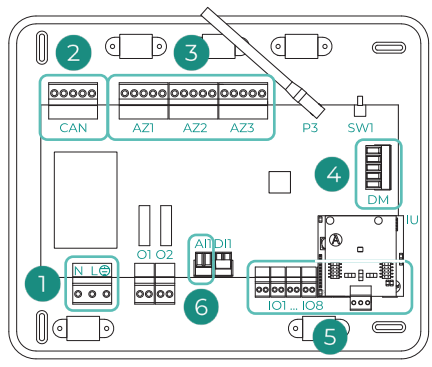
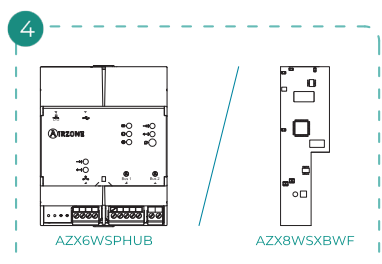
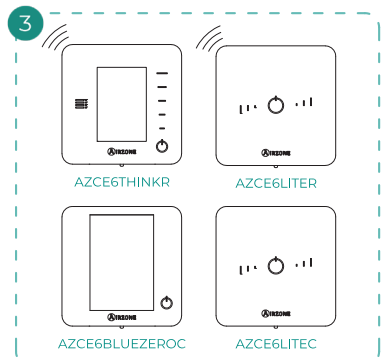
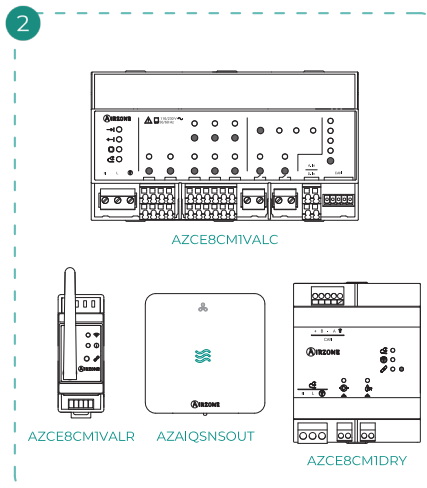

A	Azul	Blue	Azul	Bleu	Blu	Blau
-	Negro	Black	Preto	Noir	Nero	Schwarz
B	Verde	Green	Verde	Vert	Verde	Grün
+	Rojo	Red	Vermelho	Rouge	Rosso	Rot
⬇	Malla	Shield	Malha	Tresse de blindage	Calza	Schwarzer Kabelschirm

N	Neutro	Neutral	Neutro	Neutre	Neutro	Neutralleiter
L	Fase	Phase	Fase	Phase	Fase	Phase
⬇	Tierra	Ground	Terra	Terre	Terra	Schutzleiter

(ES) Ionizador Airzone
(EN) Airzone ionizer
(FR) Ioniseur Airzone
(IT) Ionizzatore Airzone
(PT) Ionizador Airzone
(DE) Airzone-Ionisator

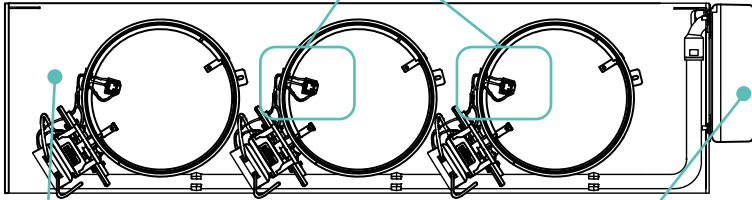

(ES) Plénum motorizado
(EN) Motorized plenum
(FR) Plénum motorisé
(IT) Plenum motorizzato
(PT) Plenum motorizado
(DE) Motorisiertes Plenum

(ES) Central del sistema
(EN) System main control board
(FR) Platine centrale du système
(IT) Scheda centrale del sistema
(PT) Central do sistema
(DE) Systemzentrale

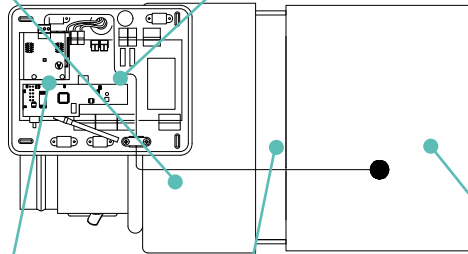

(ES) Pasarela de control
(EN) Control gateway
(FR) Passerelle de contrôle
(IT) Interfaccia di controllo
(PT) Gateway de controlo
(DE) Steuerungs-Gateway

(ES) Cuello de adaptación
(EN) Adapter collar
(FR) Col de raccordement
(IT) Ucollo di adattamento
(PT) Encaixe de adaptação
(DE) Mechanische Anpassungsmanschette

(ES) Unidad interior
(EN) Indoor unit
(FR) Unité intérieure
(IT) Unità interna
(PT) Unidade interior
(DE) Innengerät

Contents

ENVIRONMENTAL POLICY	6
BEFORE STARTING	7
ELEMENTS AND INSTALLATION	9
> Basic system elements	9
> Airzone Easyzone 25 main control board (AZC25CB1IAQ)	9
> AirQ Sensor withput VMC (AZAIQSNSOUT)	14
> Webserver Airzone Cloud	15
> Wired thermostats	18
> Wireless thermostats	19
> Single-phase/three-phase Wi-Fi electricity consumption meter (AZX8AC1MTW[1/3])	20
> Optional system elements	22
> AirQ indoor air quality Sensor (AZX6AIQSNSB)	22
> Airzone dehumidifier control module (AZCE8CM1DRY)	24
> Airzone control module for wireless valves VALR (AZCE8CM1VALR)	26
> Airzone wireless thermostatic valve actuator VALR for radiators (AZX6AC1VALR)	27
> Airzone control module for wired valves 110/230V VALC (AZCE8CM1VALC)	28
> Airzone wired thermostatic valve actuator 110/230V VALC for radiant elements (AZX6AC1VALC)	31
> Airzone hydronic production control board (AZX6CCPGAWI)	33
> Airzone KNX integration gateway (AZX6KNXGTWAY)	39
> Airzone control gateway 3 speed Fancoil (AZX6FANCOILZ)	40
> Airzone control gateway 0-10 V Fancoil (AZX6010VOLTSZ)	42
> Airzone control gateway electromechanical unit (AZX6ELECTROMECH)	44
> Clamp-on temperature probe (AZX6ACCTPA)	47
> Temperature probe in sheath (AZX6SONDPROTEC)	47

PLENUM INSTALLATION	48
> Easyzone 25 Plus Compact motorized plenum measurements	48
> Easyzone 25 Plus Compact mechanical adaptation kit	49
> Easyzone 25 Plus Compact plenum assembly	50
> Installation on the indoor unit	50
> Damper override	52
CHECKING THE INSTALLATION	53
INITIAL CONFIGURATION	55
> Airzone Blueface Zero	55
> Airzone Think	56
> Airzone Lite	58
> Checking the initial configuration	59
> System reset	59
> Zone reset	59
AIRFLOW REGULATION	60
> Airflow adjustment (REG)	60
> Minimum air adjustment (A-M)	60
SYSTEM ADVANCED SETTINGS	61
> Airzone Blueface Zero	61
> Airzone Think	61
> Airzone Cloud	61
> System parameters	62
> Zone parameters	69
> Production parameters	71
INCIDENCES	72
> Warnings	72
> Errors	73
NAVIGATION TREES	90
> Airzone Blueface Zero	90
> Airzone Think	92

Environmental policy



- Never dispose of this equipment with household waste. Electrical and electronic products contain substances that can be harmful to the environment if not properly handled. The crossed-out waste bin symbol indicates separate collection of electrical devices, which must be separated from other urban waste. For correct environmental management, at the end of its useful life the equipment should be taken to the collection centers provided for this purpose.
- The parts that make it up can be recycled. Therefore, please respect the regulations in force regarding environmental protection.
- If you replace the equipment, the original equipment must be returned to your dealer or deposited at a specialized collection center.
- Violations are subject to the penalties and measures stipulated in environmental protection law.

Before starting



- The system must be installed by a qualified technician.
- This product must not be modified or disassembled under any circumstances.
- Do not handle the system with wet or damp hands.
- In the case of any malfunction of this appliance, do not repair it yourself. Contact the sales distributor or service dealer for repair or disposal of the product.



- Check that the HVAC installation has been installed according to the manufacturer's requirements, complies with local regulations in force and is working correctly before you install the Airzone system.
- Place and connect the elements in your installation in accordance with current regulations covering electrical installations.



- All connections must be made with the power supply completely turned off.
- Take care not to short circuit any of the system's connections.
- Please refer carefully to the wiring diagram and these instructions when wiring.
- Connect all wiring securely. Loose wiring may cause overheating at the connection points and is a possible fire hazard.
- Do not locate the Airzone communication bus close to power lines, fluorescent lights, actuators, etc. as this may cause interference in communications.



- The connection to the external power supply must include a main switch or other method of disconnection that includes a constant separation for all polarities, in accordance with appropriate local and national regulations. The system will automatically restart if the power supply is turned off. **Use separate circuits for the unit that is to be controlled and the power supply to the system.**
- Check the polarity of each device's connectors. A wrong connection can seriously damage the product.
- To connect to the system, use Airzone cable: four-wire cable (2x0.22 mm² twisted shielded wires for data communications and 2x0.5 mm² wires for power supply).

- A Blueface Zero thermostat must be used to enable all the Airzone system functionalities.
- Recommendations for the placing of the thermostats:



- An Internet connection is required to ensure correct operation of the Webserver, enabling the system to be controlled remotely using the Airzone Cloud app.
- For equipment using R32 refrigerant, verify the compliance with the local refrigerant regulation.
- The room size installation requirements mentioned in the manual of the ducted indoor unit, to which the Easyzone is connected, remain applicable to each and every separate room served by the Airzone system.
- Ducts connected to Easyzone shall not contain a potential ignition source.
- Recommendations for placing the AirQ Sensor device:
 - ◇ Install the sensor on the wall at a height between 0.9 and 1.8 m above the ground.
 - ◇ Leave a clear area around the device.
 - ◇ Avoid placing the AirQ Sensor near to polluting sources or where people can breathe on it directly.
 - ◇ Avoid placing the device near to supply grilles, windows or doors. To this end, leave a space of at least 5 m from these elements.
 - ◇ Avoid placing the sensor near to heat sources.

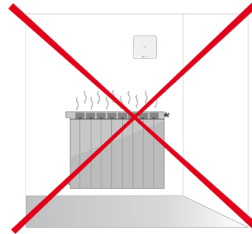
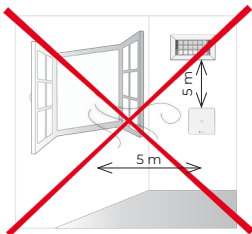
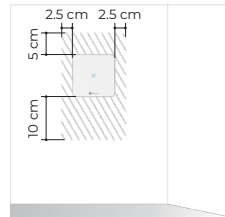
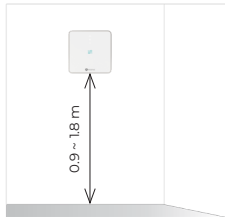

Elements and installation

BASIC SYSTEM ELEMENTS

Airzone Easyzone 25 main control board (AZC25CB1IAQ)

For further information, see the [technical datasheet](#).

Assembly

The system's main control board is delivered installed in the plenum. For replacement, follow these steps:

1. Locate the control board close to the unit to be controlled.
2. Unscrew the cover securing the back part to the plenum. Minimum screw dimensions: $\varnothing = 4.5 \text{ mm}$, $L = 25 \text{ mm}$.
3. Make all the connections and screw the cover again.

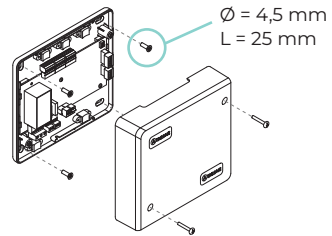

Connection

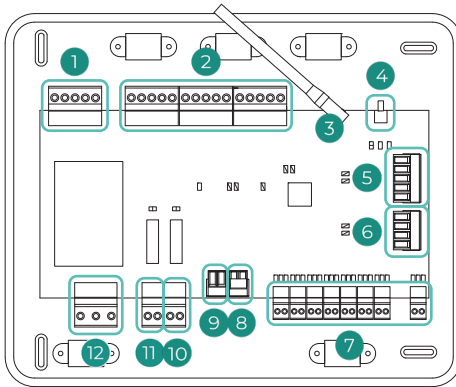

N°	Description
①	CAN bus
②	Airzone connection bus
③	Antenna
④	Wireless connection
⑤	Automation bus
⑥	AC unit bus
⑦	Actuator / ionizer outputs
⑧	Digital input
⑨	Analog input
⑩	Low temperature circuit
⑪	High temperature circuit
⑫	Power supply

Important: You will have the option of incorporating a zone On/Off control module (AZCE8ACCOFF) on the main control board.

For further information on the On/Off module, see the [technical datasheet](#).

CAN bus

The CAN bus allows the different system elements to be connected to the main control board, enabling communication between them. The devices that can be connected to this bus are:

- Purification devices (AirQ Sensor)
- Dehumidifier module (AZCE8CM1DRY)
- Valve control modules (AZCE8CM1VALC / AZCE8CM1VALR)

To connect to the bus, there is one 5-pin terminal. Use 2x0.5 + 2x0.22 mm² Airzone cable. Fix the cables with the screws on the terminal, following the color code.

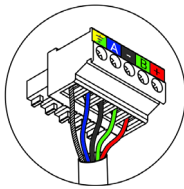

A	Blue
-	Black
B	Green
+	Red
⏏	Shield

For increased safety, fix the cables to the main control board using the turrets:

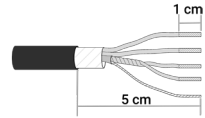
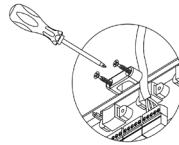

Airzone connection bus (AZ1 - AZ2 - AZ3)

The Airzone connection bus is used to connect all the internal elements independent of the main control board and can control up to 8 zones. The devices that can be connected to this bus are:

- Wired thermostats (AZCE6BLUEZEROC / AZCE6LITEC)
- Wireless thermostats (AZCE6THINKR / AZCE6LITER)

To connect to the bus, there are three 5-pin terminals. This system allows star and bus connection. Use 2x0.5 + 2x0.22 mm² Airzone cable. Fix the cables with the screws on the terminal, following the color code.

Important: For elements with external power supply at 110/230 VAC, it is only necessary to connect poles "A" and "B" of the bus for communications.

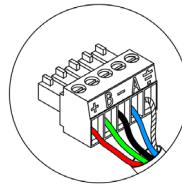

A	Blue
-	Black
B	Green
+	Red
⏏	Shield

Antenna (P3)

Antenna connection for wireless elements.

Wireless connection (SW1)

The system main control board has wireless communication for connecting wireless Airzone elements. These devices are associated by opening the association channel on the main control board. To do this, make a short press on SW1; when LED D19 stays red it means that the radio channel is open. For 15 minutes, the system will keep the wireless association channel open.

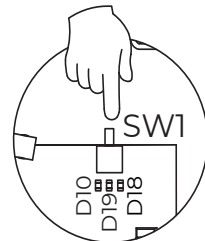

Automation bus (DMI)

The automation bus allows several systems to be interconnected in order to manage all of them, using the control peripherals offered by Airzone or their integration into a higher-level control network. The devices that can be connected to this bus are:

- Airzone Cloud Webserver (AZX8WS1BWF / AZX6WSC5GER / AZX6WSPHUB)
- Production control board (AZX6CCPGAWI)
- KNX integration gateway (AZX6KNXGTWAY)

To connect to the bus, there is one 5-pin terminal. This system only uses bus connections. Fix the cables with the screws on the terminal, following the color code.

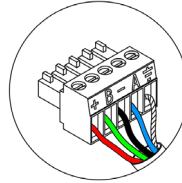

A	Blue
-	Black
B	Green
+	Red
⏏	Shield

AC unit bus (IU)

The AC unit bus makes it possible to connect various control gateways to the installed AC unit. The devices that can be connected to this bus are:

- Control gateways (AZX8GTCxx)
- Three-speed fancoil gateway (AZX6FANCOILZ)
- 0-10 V fancoil control gateway (AZX6010VOLTSZ)
- Electromechanical unit control gateway (AZX6ELECTROMECH)

To connect to the bus, there is one 4-pin terminal. The connection of these elements is point to point. Fix the cables with the screws on the terminal, following the color code.

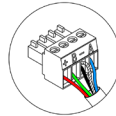

A	Blue
-	Black
Shield	Shield
B	Green
+	Red

Important: For elements with external power supply at 110/230 VAC, it is only necessary to connect poles "A", "B" and "Shield" of the communications bus. Only use the shield on the connector on the main control board side.

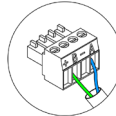

A	Blue
B	Green

To connect integrated gateways, disconnect the AC unit bus terminal and fit the connector and the gateway fixing post.

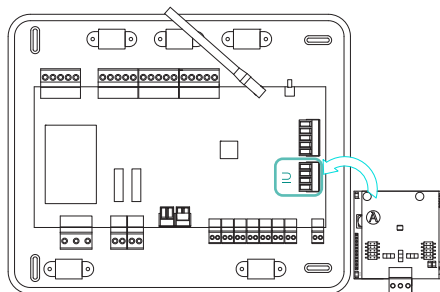

Actuator / ionizer outputs (IO1 ... IO8)

Connection outputs to ionizers and actuators. Factory connected.

Digital input (DI1)

This configurable digital input allows external sensors to be connected to the system to activate alarms via digital signals.

Analog input (AI1)

Allows the return temperature of an AC unit to be measured by means of an external probe. The use of this probe is recommended when working with electromechanical or NON Inverter units, where the return temperature of the AC unit must be controlled.

Low temperature circuit (O2)

This output can be configured as "Low temp. circuit demand" (Underfloor heating) (by default) or as "Manual" (see Advanced settings section on the Blueface Zero thermostat → System parameters).

- Low temp. circuit demand configuration: The output must be configured as "Underfloor heating water"* (by default).

Status	Stop	Ventilation	Air Cooling	Radiant Cooling	Air Heating	Radiant Heating	Radiator
Demand ON	OFF	OFF	OFF	ON	OFF	ON	OFF
Demand OFF	OFF	OFF	OFF	OFF	OFF	OFF	OFF

*If the output is configured as "Radiant electric", neither the main control board relay nor the CCP relay will be activated.

- Manual configuration (requires Webserver version equal to or later than 4.0.1): ON/OFF control through Airzone Cloud (requires version equal to or later than 4.11).

The technical characteristics of the O2 relays are: I_{max} 1 A at 24-48 V voltage free. To control higher power elements, the use of contactors of the power to be controlled is recommended.

High temperature circuit (O1)

This output can be configured as "High temp. circuit demand" (Air/Radiator) (by default) or as "Manual" (see Advanced settings section on the Blueface Zero thermostat → System parameters).

- High temp. circuit demand configuration: The output must be configured as "Fancoil"* (by default) or "Radiator/Ceiling water".

Status	Stop	Ventilation	Air Cooling	Radiant Cooling	Air Heating	Radiant Heating	Radiator
Demand ON	OFF	ON	ON	OFF	ON	OFF	ON
Demand OFF	OFF	OFF	OFF	OFF	OFF	OFF	OFF

*If a communication gateway is connected to the main control board, the output type will be configured automatically as "Direct expansion" and the relay will not be activated.

- Manual configuration (requires Webserver version equal to or later than 4.0.1): ON/OFF control through Airzone Cloud (requires version equal to or later than 4.11).

The technical characteristics of the O1 relays are: I_{max} 1 A at 24-48 V voltage free. To control higher power elements, the use of contactors of the power to be controlled is recommended.

Power supply (N L ⊕)

This connector supplies power to the system main control board and consequently to the elements connected to it. External power supply at 110/230 VAC.

The power connection to the module is via a 3-pin terminal. Use 3x1.5 mm² cable. Fix the cables with the screws on the terminal, following the color code.

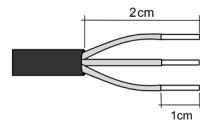
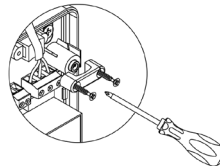
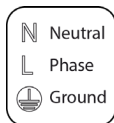
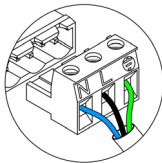

The connection to the external power supply must include a main switch or other method of disconnection that includes a constant separation for all polarities, in accordance with appropriate local and national regulations. The system will automatically restart if the power supply is turned off. **Use separate circuits for the unit that is to be controlled and the power supply to the system.**

Once all the connections have been made, make sure the cover of the main control board is correctly replaced.

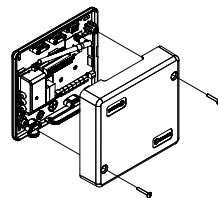

AirQ Sensor without VMC (AZAIQSNSOUT)

For further information, see the [technical datasheet](#).

Assembly and connection

It is recommended to install the device at a height between 0.9 and 1.8 m above the ground. For residential installations, it is recommended that the location of the device be in daytime or transit rooms (e.g., hallways). The AirQ Sensor is surface mounted on a support.

Follow the steps below to carry out the installation:

1. Separate the back of the AirQ Sensor and fix the cables with the screws on the terminal, following the color code.
Important: Use the tool provided to press on the fastening tabs.
2. Position and screw the base of the device.
3. Connect it the CAN bus. For increased safety, fix the cables to the main control board using the turrets.
4. Fit the top of the AirQ Sensor into the protruding rib on the base.
5. Rotate until the device is fully secured by the magnets.
6. You can secure the device by a small anti-theft screw located at the bottom (optional).

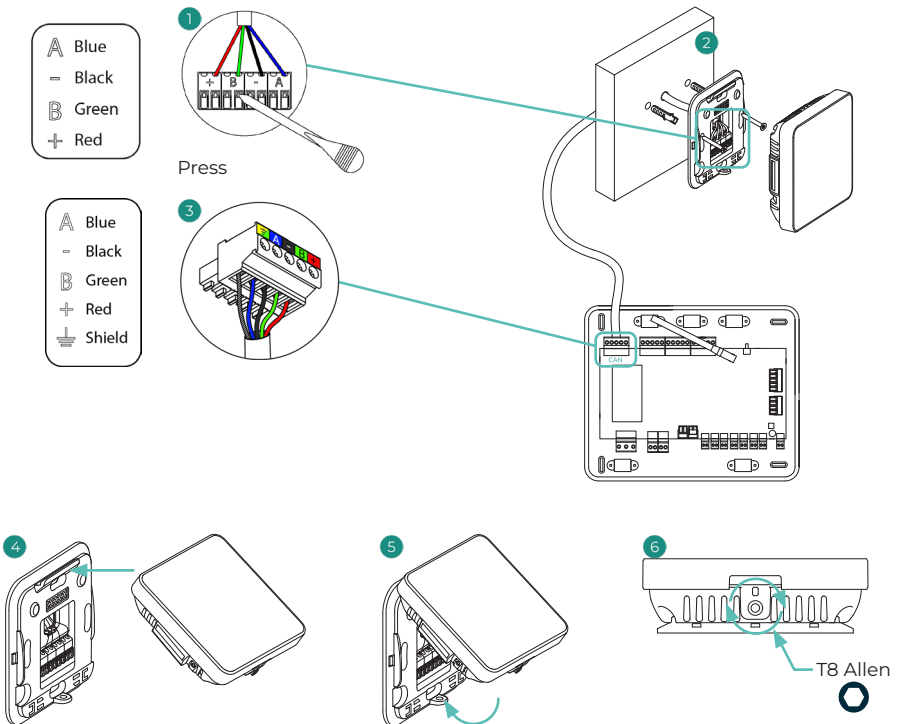

Webserver Airzone Cloud

Webserver Airzone Cloud Wi-Fi (AZX8WS1BWF)

For further information, see the [technical datasheet](#).

Assembly and connection

The Webserver Airzone Cloud Wi-Fi (AZX8WS1BWF) is delivered installed in the main control board automation bus.

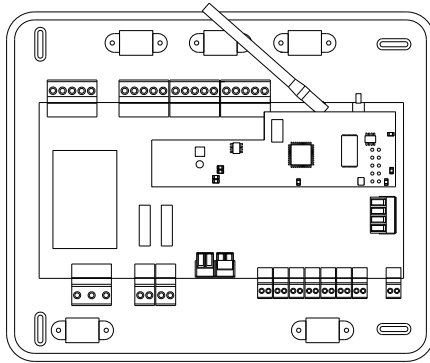

Important: You cannot interconnect several main control boards with this Webserver. To do this, you require the Webserver HUB (AZX6WSPHUB).

Webserver HUB Airzone Cloud Dual 2.4-5G/Ethernet (AZX6WSPHUB)

For further information, see the [technical datasheet](#).

Assembly

The Webserver HUB (AZX6WSPHUB) is DIN rail or surface mounted. The location and assembly of this module must comply with current electronic regulations.

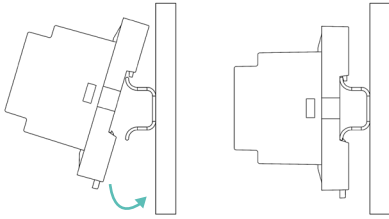

Mounted using DIN rail

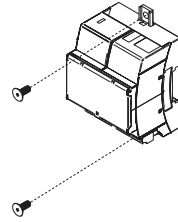

Mounted on wall

Note: To remove the module on DIN rail, pull the tab downwards to release it.

Connection

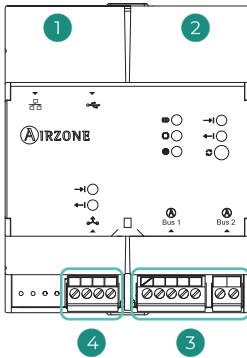

Nº	Description
1	Ethernet
2	Wi-Fi
3	Automation bus
4	Integración output

Ethernet

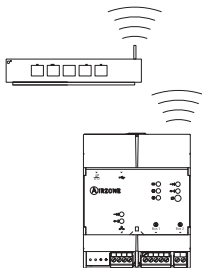

Wi-Fi

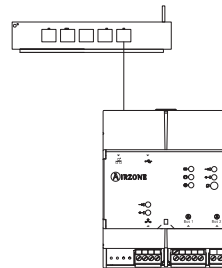

Important: All Airzone systems must be connected to the internet to provide technical support.

Automation bus (DM1 - DM2)

The Webserver HUB is an element that connects to the automation bus on the system's main control board.

For connection to the bus there is one 5-pin terminal (DM1). Fix the cables with the screws on the terminal, following the color code. Only use the shield on the connector on the main control board side. To connect several main control boards, use the 2-pin terminal (DM2).

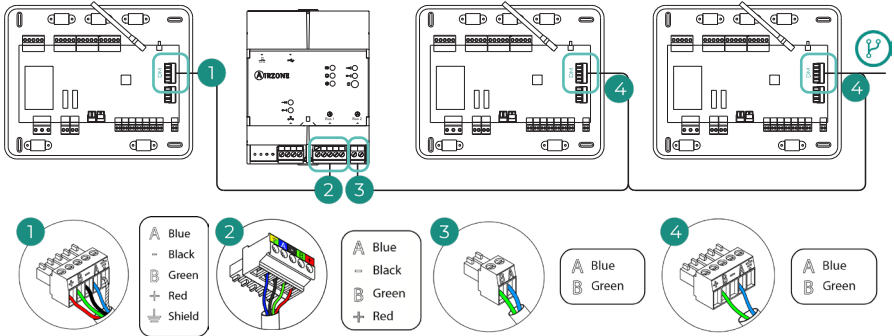

AZX6WSPHUB from a system main control board to other system main control boards

To connect the Webserver HUB to a CCP, use the CCP's outdoor automation bus 2.

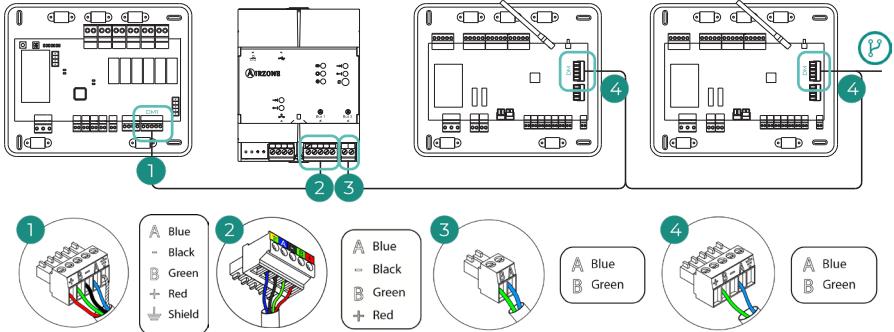

AZX6WSPHUB from AX6CCPGAWI to system main control boards

It is only necessary to connect **one Webserver per installation**. The connection icon  indicates that the same connection can be made for a total of up to 32 systems.

Note: Remember that, for this module to work correctly, all the main control boards in the installation must be addressed (see System advanced settings section).

Important: If replacing a Webserver Wi-Fi (AZX8WS1BWF) with a Webserver HUB (AZX6WSPHUB), disconnect the former and connect the latter using the 5-pin terminal supplied with the main control board.

Wired thermostats

Airzone Blueface Zero wired thermostat (AZCE6BLUEZEROC)

For further information, see the [technical datasheet](#).

Airzone Lite wired thermostat (AZCE6LITEC)

For further information, see the [technical datasheet](#).

Assembly and connection

Airzone wired thermostats are surface mounted on a support. Remember that the maximum recommended distance for this device is 40 meters. For wall mounting, follow these steps:

1. Separate the back of the thermostat and fix the cables with the screws on the terminal, following the color code.
Important: Use the tool provided to press on the fastening tabs.
2. Fix the back of the thermostat to the wall.
3. Connect the Airzone connection bus to any of the three terminals (AZ1, AZ2 or AZ3). For increased safety, fix the cables to the main control board using the turrets.
4. Place the display over the fixed support.
5. Place the anti-vandalism rods to better hold the thermostat in place (optional).

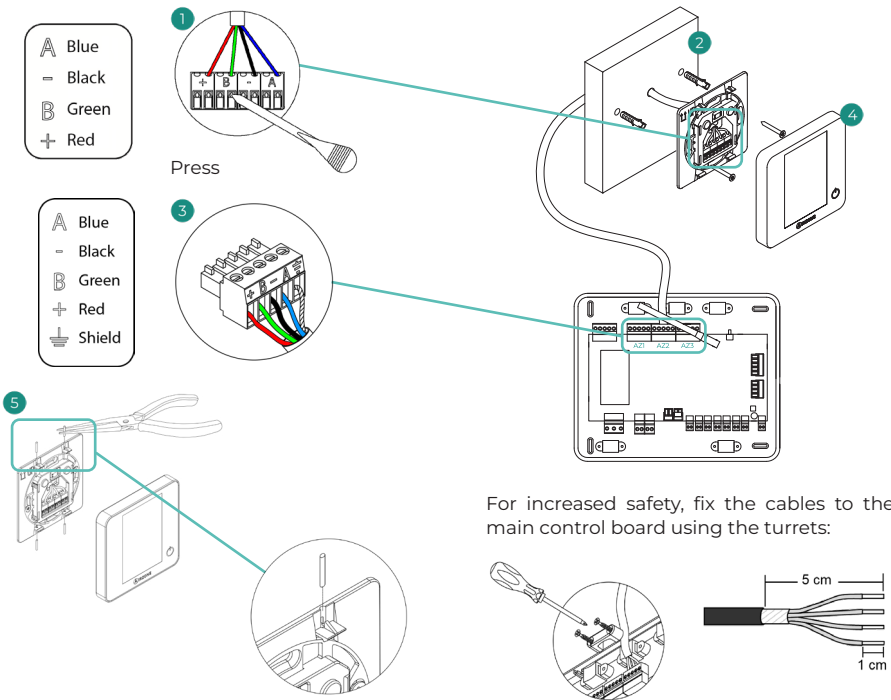

For increased safety, fix the cables to the main control board using the turrets:

Note: If more than five AZCE6BLUEZEROC thermostats are connected to a main control board, an additional power supply AZX6POWER must be added. For further information, see the [technical datasheet](#).

Wireless thermostats

Airzone Think wireless thermostat (AZCE6THINKR)

For further information, see the [technical datasheet](#).

Airzone Lite wireless thermostat (AZCE6LITER)

For further information, see the [technical datasheet](#).

Assembly

Airzone wireless thermostats are surface mounted on a support. Remember that the maximum recommended distance for this device is 40 meters.

For wall mounting, follow these steps:

1. Remove the back of the thermostat and insert the CR2450 button battery.
2. Fix the back of the thermostat to the wall.
3. Place the display over the fixed support.
4. Place the anti-vandalism rods to better hold the thermostat in place (optional).

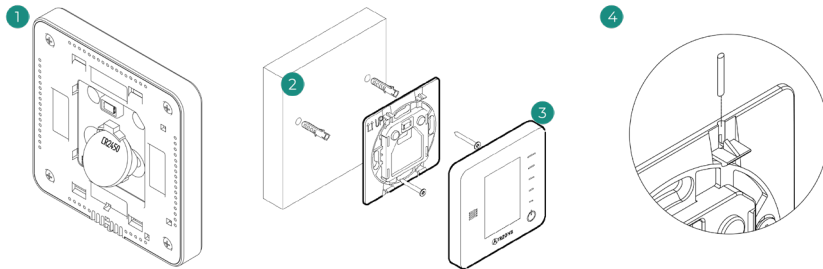

Note: If you wish to change the battery, please see the [User's Manual](#).

Single-phase/three-phase Wi-Fi electricity consumption meter (AZX8AC1MTW[1/3])

For further information, see the [technical datasheet](#).

Assembly

This device is DIN rail mounted. This module is externally powered at 220 VAC. The location and assembly of this module must comply with current electronic regulations.

Note: To remove the module, pull the tab downwards to release it.

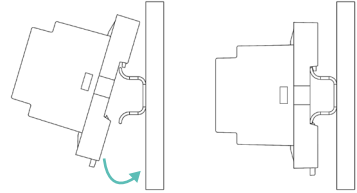

Connection

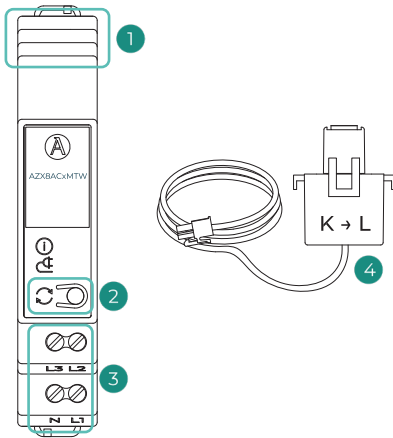

N°	Description
①	Ix: Signal inputs
②	Reboot / Reset
③	Lx - N: Power supply
④	Clamp for electricity consumption measurement (AZX8ACCMTWC)

Measurement clamp connection

Connect a measuring clamp to each signal input. To measure the consumption of a single unit, connect the clamp to phase 1 (I1).

Note: Place each measuring clamp around a single phase line, checking that the clamp orientation is correct.

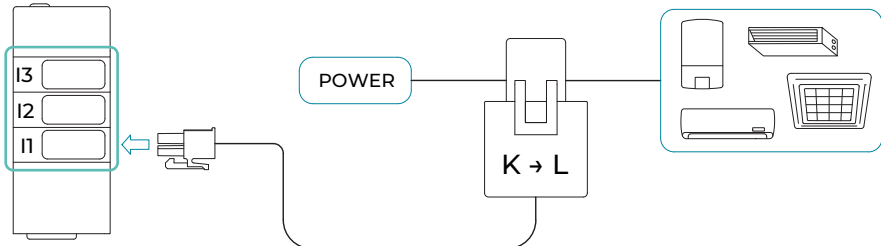

Power supply

The power connection to the module will depend on the network to which it will be connected (single-phase or three-phase):

- Single-phase power supply: the meter will always be powered through lines 1 and Neutral.
- Three-phase power supply: the meter will always be powered through lines 1, 2, 3 and Neutral.

Fix the cables with the screws on the terminal, following the polarity.

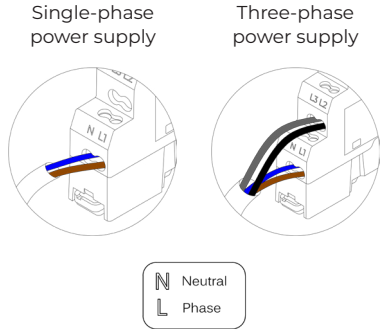

Reboot

To reboot the device, briefly press the button .

Factory reset

If you need to reset the consumption meter to factory settings, press and hold the button  for 10 seconds. Wait for the LED to return to their normal status and then repeat the initial configuration.

OPTIONAL SYSTEM ELEMENTS

AirQ indoor air quality Sensor (AZX6AIQSN5B)

For further information, see the [technical datasheet](#).

Assembly

It is recommended to install the device at a height between 0.9 and 1.8 m above the ground. For residential installations, it is recommended that the location of the device be in daytime or transit rooms (e.g., hallways). The AirQ Sensor is surface mounted on a support.

Follow the steps below to carry out the installation:

1. Position and screw the base of the device to the embedded box.
2. Fit the top of the AirQ Sensor into the protruding rib on the base.
3. Rotate until the device is fully secured by the magnets.
4. You can secure the device by a small anti-theft screw located at the bottom (optional).

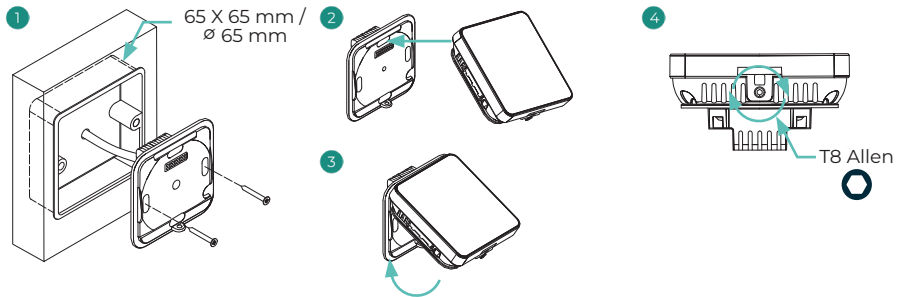

Connection

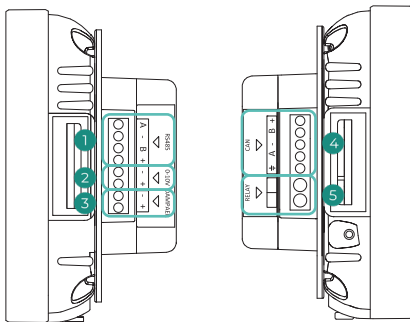

N°	Description
1	Integration bus
2	0-10 V output (CMV)
3	Airzone damper control
4	CAN bus
5	Relay output (CMV remote On/Off)

CAN bus

Connect the AirQ Sensor to the CAN bus of the main control board. To do this, there is one 5-pin terminal. Use 2x0.5 + 2x0.22 mm² Airzone cable. Fix the cables with the screws on the terminal, following the color code.

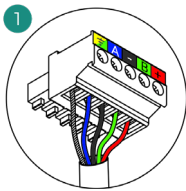
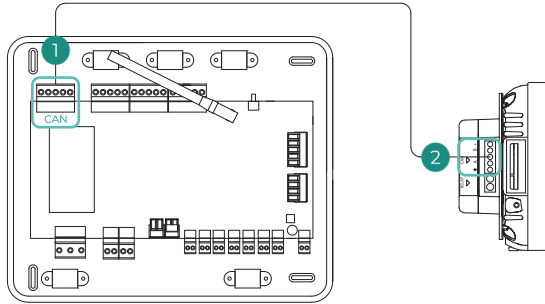

- A Blue
- Black
- B Green
- + Red
- Shield

For increased safety, fix the cables to the main control board using the turrets:

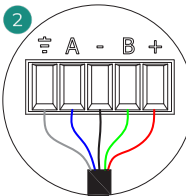
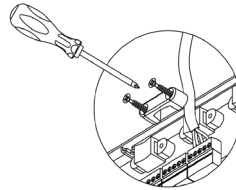

- A Blue
- Black
- B Green
- + Red
- Shield

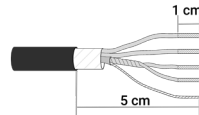

Airzone dehumidifier control module (AZCE8CM1DRY)

For further information, see the [technical datasheet](#).

Assembly

This module is DIN rail mounted. It is externally powered at 110/230 VAC. It should be placed and mounted in accordance with the current electrotechnical regulations.

Note: To remove the module on DIN rail, pull the tab downwards to release it.

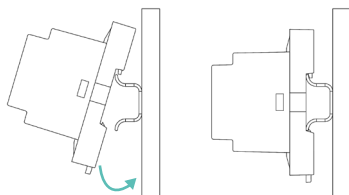

Connection

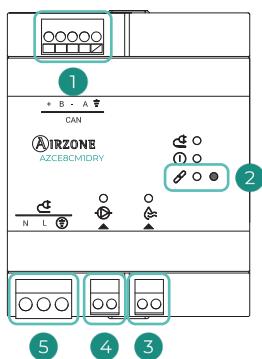

N°	Description
①	CAN bus
②	Reset
③	Relay output (fan)
④	Relay output (pump)
⑤	Power supply

CAN bus

Connect the AZCE8CM1DRY module to the CAN bus of the main control board. For this purpose, there is one 5-pin terminal. Use 2x0.5 + 2x0.22 mm² Airzone cable. Fix the cables with the screws on the terminal, following the color code.

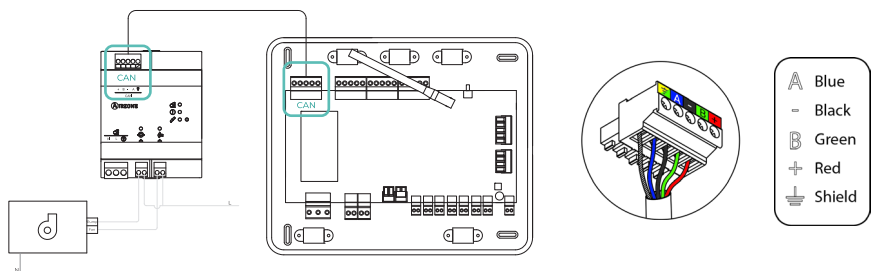

For increased safety, fix the cables to the main control board using the turrets:



Relay outputs

Relay specs:

⚙️ Pump I_{max}: 12 A at 250 VAC / 12 A at 24 VDC.

⚙️ Fan I_{max}: 5 A at 250 VAC / 3 A at 30 VDC.

Note that to control elements with a greater power, it is recommended to use contactors in accordance with the power required. Remember to connect the neutral connector directly from the circuit to the element to be controlled.

Power supply (⚡)

The dehumidifier module is externally powered at 110/230 VAC. The power connection to the module is via a 3-pin terminal. Fix the cables with the screws on the terminal, following the color code.

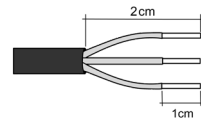
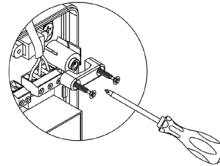
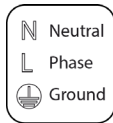
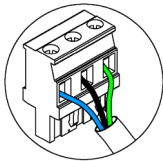

The connection to the external power supply must include a main switch or other method of disconnection that includes a constant separation for all polarities, in accordance with appropriate local and national regulations. The system will automatically restart if the power supply is turned off. **Use separate circuits for the unit that is to be controlled and the power supply to the system.**

Factory reset

If you want to return to factory values, press and hold the button  until all LED turn on. Wait for the LED to go back to their normal state before starting with the initial configuration process.

Airzone control module for wireless valves VALR (AZCE8CM1VALR)

For further information, see the [technical datasheet](#).

Assembly

This module is mounted on DIN rail. It should be placed and mounted in accordance with the current electrotechnical regulations.

Note: To remove the module on DIN rail, pull the tab downwards to release it.

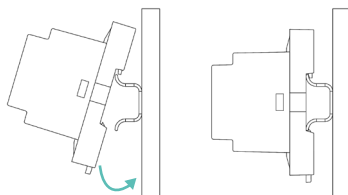

Connection

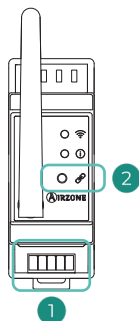

N°	Description
①	CAN bus
②	Association / Reset

CAN bus

Connect the AZCE8CM1VALR module to the CAN bus of the main control board. For this purpose, there is one 5-pin terminal. Use 2x0.5 + 2x0.22 mm² Airzone cable. Fix the cables with the screws on the terminal, following the color code.

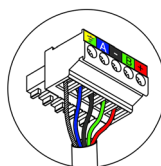
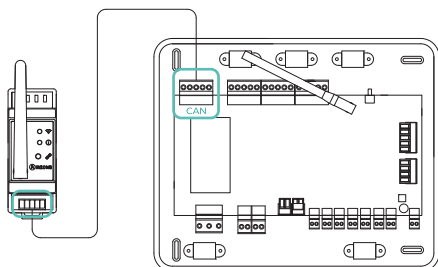

A	Blue
-	Black
B	Green
+	Red
⊥	Shield

For increased safety, fix the cables to the main control board using the turrets:

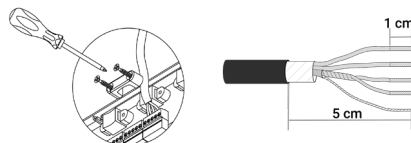

Reset

If you want to return to factory values, press and hold the association button  until LED ① change to searching status (blue). Wait for the LED to go back to their normal state before starting with the initial configuration process.

Airzone wireless thermostatic valve actuator VALR for radiators (AZX6AC1VALR)

For further information, see the [technical datasheet](#).

Assembly

Airzone wireless thermostatic valve actuators are mounted on each of the valves of a heater. Check that the thermostatic valve actuator is compatible with the valve body that you are going to equip (M30 x 1.5). See [compatibility table](#).

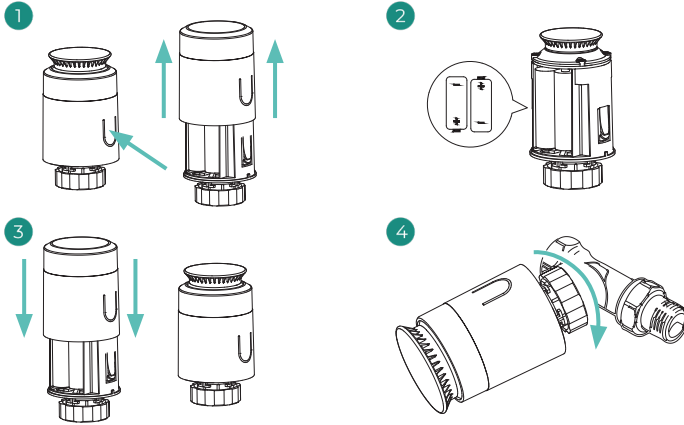

Association

To associate the heads, follow the steps below:

1. Open the association channel by pressing the  button.
2. Turn the upper wheel of the head until "OF" appears on the screen.
3. Press and hold the upper button until the address of the thermostatic head appears on the display (an address from 01 to 10 is automatically assigned).

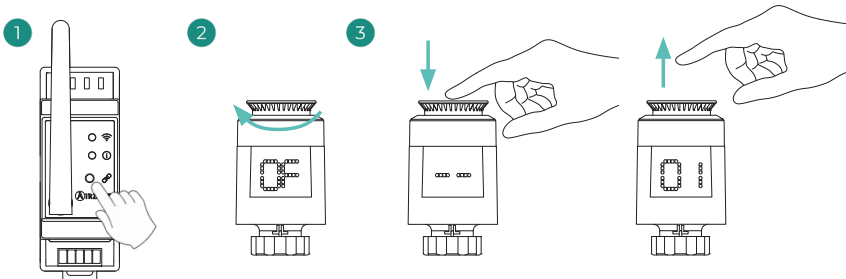

Airzone control module for wired valves 110/230V VALC (AZCE8CM1VALC)

For further information, see the [technical datasheet](#).

Assembly

This module is DIN rail or surface mounted. It is externally powered at 110/230 Vac. It should be placed and mounted in accordance with the current electrotechnical regulations.

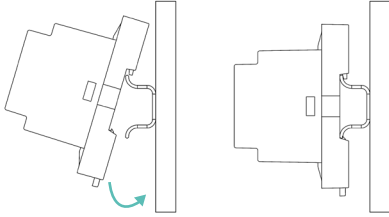

Mounted using DIN rail

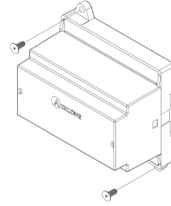

Mounted on wall

Note: To remove the module on DIN rail, pull the tab downwards to release it.

Connection

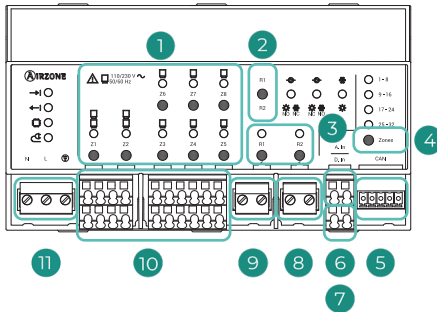

N°	Description
①	Zone relay buttons
②	Operation relay configuration
③	Operation relay buttons
④	Reset
⑤	CAN bus
⑥	Analog input
⑦	Digital input (Forced mode)
⑧	Operation relay R2
⑨	Operation relay R1
⑩	Outputs for thermostatic heads
⑪	Power supply

CAN bus

Connect the AZCE8CMIVALC module to the CAN bus of the main control board. For this purpose, there is one 5-pin terminal. Use $2 \times 0.5 + 2 \times 0.22 \text{ mm}^2$ Airzone cable. Fix the cables with the screws on the terminal, following the color code.

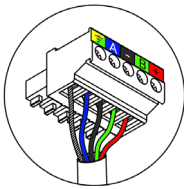
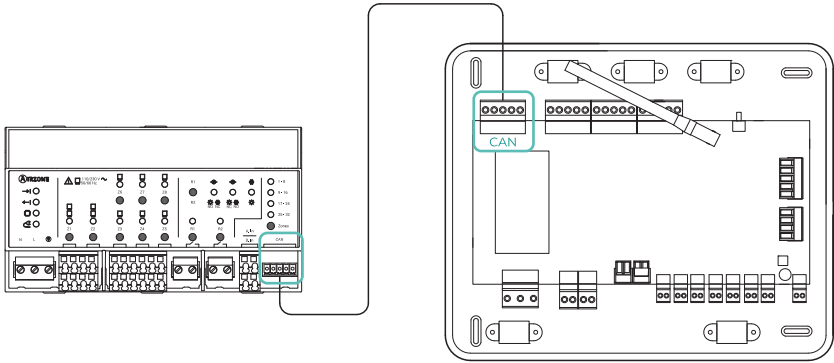

A	Blue
-	Black
B	Green
+	Red
⏏	Shield

For increased safety, fix the cables to the main control board using the turrets:



Outputs for thermostatic heads

Control Z1 - Z8 relay specs: $I_{max} = 5 \text{ A}$ at 110/250 VAC.

Note that to control elements with a greater power, it is recommended to use contactors in accordance with the power required. Remember to connect the neutral connector directly from the circuit to the element to be controlled.

Power supply (N L ⊕)

The module for wired valves is externally powered at 110/230 VAC. The power connection to the module is via a 3-pin terminal. Fix the cables with the screws on the terminal, following the color code.

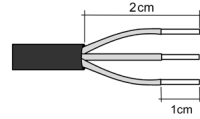
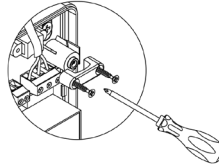
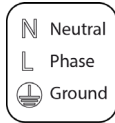
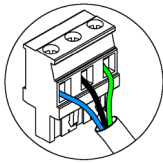









The connection to the external power supply must include a main switch or other method of disconnection that includes a constant separation for all polarities, in accordance with appropriate local and national regulations. The system will automatically restart if the power supply is turned off. **Use separate circuits for the unit that is to be controlled and the power supply to the system.**

Configuration

Configure the AZCE8CM1VALC module according to your installation. To do this you must leave the LED that corresponds to your installation on:

1. Press the operation relays configuration button for 5 s.
2. Switch between the different configurations by pressing the same button.
3. Save the configuration by another 5 s pressing in the same button.



Configuration / Relay output	Configuration 1   	Configuration 2   	Configuration 3   
R1	On/Off Pump	On/Off Pump	Cooling Mode
R2	Heating Mode: Normally open Cooling Mode: Normally closed	Heating Mode: Normally closed Cooling Mode: Normally open	Heating Mode

The relay R1 is activated when demand is generated in the system with a 3-minute delay.

The relay R2 maintains the last requested mode (cooling or heating), when selecting Stop/Ventilation/Dry mode.

Factory reset

Press and hold  Zones for 10 seconds to return module to factory settings.

Airzone wired thermostatic valve actuator 110/230V VALC for radiant elements (AZX6AC1VALC)

For further information, see the [technical datasheet](#).

Assembly

Airzone wired thermostatic valve actuators are mounted on each of the valves of a manifold / heater. Check that the thermostatic valve actuator is compatible with the valve body that you are going to equip (M30 x 1.5). See [compatibility table](#).

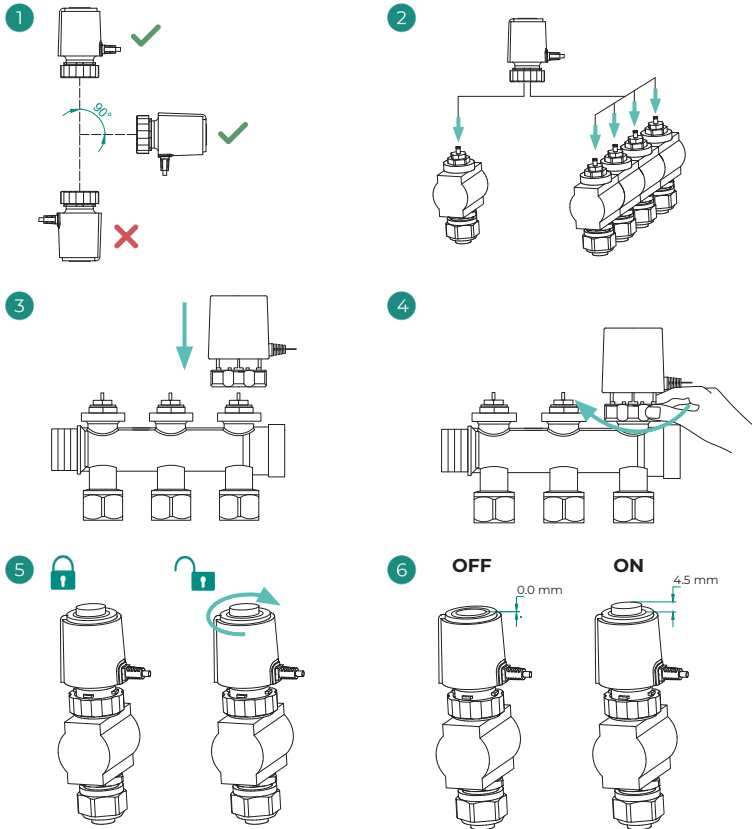

Connection

Airzone wired thermostatic heads are elements that are connected to the Z1 - Z8 outputs on the AZCE8CMIVALC. Connect through 2 wires without polarity. Maximum number of valves permitted: 2 for each output (20 valves in total).

Important: Use a suitable screwdriver to press in the locking tabs.

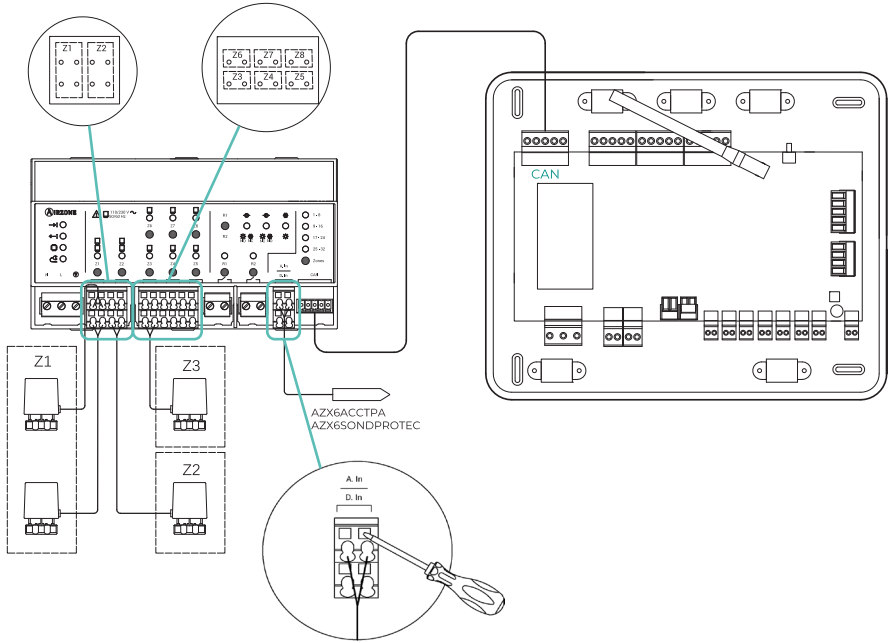

Airzone hydronic production control board (AZX6CCPGAWI)

For further information, see the [technical datasheet](#).

Assembly

The production control board is delivered in a screwed box for surface mounting. The location and installation of this element must comply with the current electronic regulations.

To mount the production control board, follow these steps:

1. Locate the production control board close to the AC unit to be controlled.
2. Unscrew the cover to fix the rear part to the wall. Minimum screw dimensions: $\varnothing = 4.5 \text{ mm}$, $L = 25 \text{ mm}$.
3. Once all connections have been made, screw the cover back on.

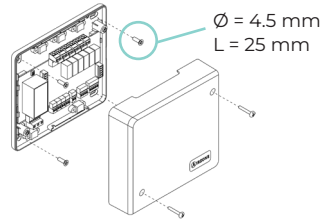

Connection

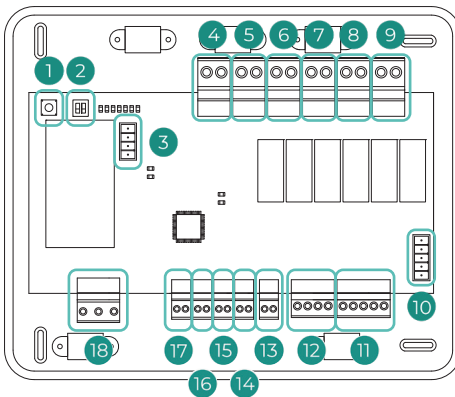

N°	Description
①	System search
②	Configuration
③	Air-to-Water automation bus
④	Cooling mode
⑤	Heating mode
⑥	Air demand (cooling)
⑦	Radiant demand (cooling)
⑧	Air demand (heating)
⑨	Radiant demand (heating)
⑩	Automation bus
⑪	Automation bus
⑫	Integration bus
⑬	Airzone internal use
⑭	Stop mode
⑮	Semi-forced cooling mode
⑯	Semi-forced heating mode
⑰	DHW mode
⑱	Power supply



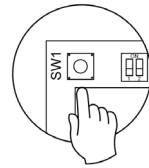

System search (SW1)

A short press on SW1 forces the production control board to search for the systems connected to it and to set the addressing configuration. To reset the CCP, press SW1 for 10 seconds.



Configuration (SW2)

The SW2 microswitch configures the type of installation to be controlled by the production control board. The operation logic of the microswitch is as follows:

Meaning			
			
Air-to-Water HP	2 pipes	3/4 pipes	RadianT

Air-to-Water automation bus (IU)

This bus makes it possible to connect various air to water gateways to the installed air-water unit.

To connect these integrated gateways, disconnect the AC unit bus terminal and fit the connector and the gateway fixing post.

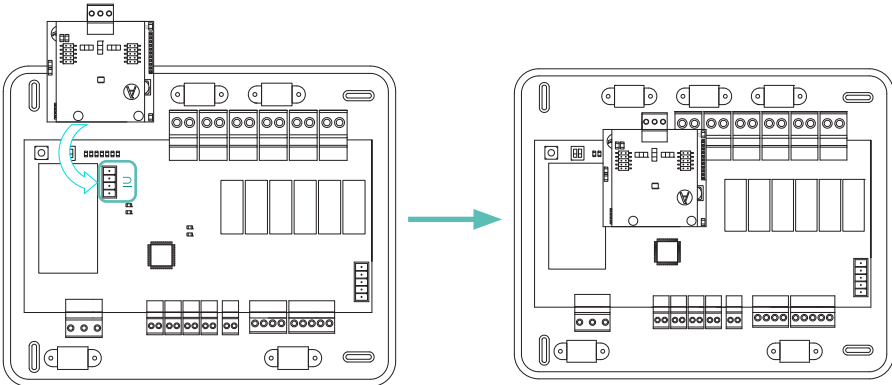





Control relays

This device has 6 relays for controlling the installation. The characteristics of the control relays are I_{max} 10 A at 110/230 VAC voltage free. To control higher power elements, the use of contactors of the power to be controlled is recommended.

Important: Remember to connect the neutral directly from the circuit to the element to be controlled.





Depending on the type of installation configured, the control relays will have a logic adapted to the installation:

- **Air-to-Water Heat Pump**

Mode	Demand	Control relays					
		MODE_Y	MODE_W	AIR_Y	RAD_Y	AIR_W	RAD_W
Stop	OFF	-	-	-	-	-	-
Cooling		ON	-	ON	-	-	-
		ON	-	-	ON	-	-
	OFF	-	-	-	-	-	-
Heating		-	ON	-	-	ON	-
		-	ON	-	-	-	ON
	OFF	-	-	-	-	-	-
Dry	ON	-	-	-	-	-	-
	OFF	-	-	-	-	-	-
Ventilation	ON	-	-	-	-	-	-
	OFF	-	-	-	-	-	-



 Air /  Radiator /  Radiant

- 2 pipes / 4 pipes

Mode	Demand	Control relays					
		MODE_Y	MODE_W	AIR_Y	RAD_Y	AIR_W	RAD_W
Stop	OFF	-	-	-	-	-	-
Cooling		ON	-	ON	-	-	-
		ON	-	-	ON	-	-
	OFF	ON	-	-	-	-	-
Heating		-	ON	-	-	ON	-
		-	ON	-	-	-	ON
	OFF	-	ON	-	-	-	-
Dry	ON	ON	-	-	-	-	-
	OFF	ON	-	-	-	-	-
Ventilation	ON	-	-	-	-	-	-
	OFF	-	-	-	-	-	-

 Air /  Radiator /  Radiant

- RadianT

Mode	Demand	Control relays					
		MODE_Y	MODE_W	AIR_Y	RAD_Y	AIR_W	RAD_W
Stop	OFF	-	-	-	-	-	-
Cooling		ON	-	-	ON	-	-
	OFF	ON	-	-	-	-	-
Heating		-	ON	-	-	ON	-
		-	ON	-	-	-	ON
	OFF	-	ON	-	-	-	-

 Radiator /  Radiant

Important: In order to optimize the production temperature of the air to water units, the following combinations will not generate air demand in the production control board:

- Airzone 3.0 control gateway (AZX8GTCxxx) in the system main control boards.
- Airzone control gateway - Electromechanical unit (AZX6ELECTROMECH) in system main control boards.

Automation bus (DM2)

For the Airzone Cloud Webserver connection, remove the Webserver fixing post and fit the connector on the outdoor domotic bus.

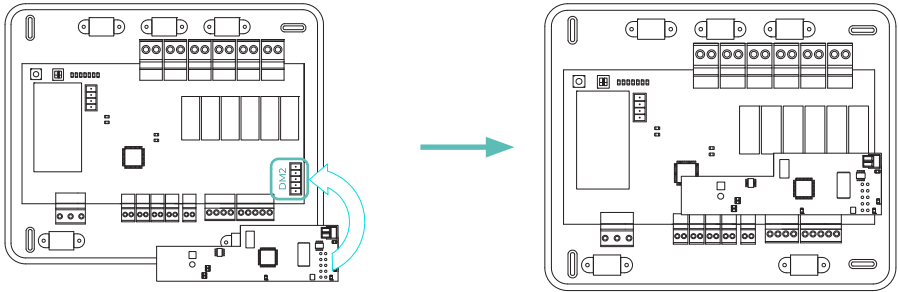

Automation bus (DM1)

The outdoor domotic bus allows several systems to be interconnected in order to manage all of them, using the control peripherals offered by Airzone or their integration into a higher-level control network.

To connect to the bus, there is one 5-pin terminal. This system only uses bus connections. Fix the cables with the screws on the terminal, following the color code.

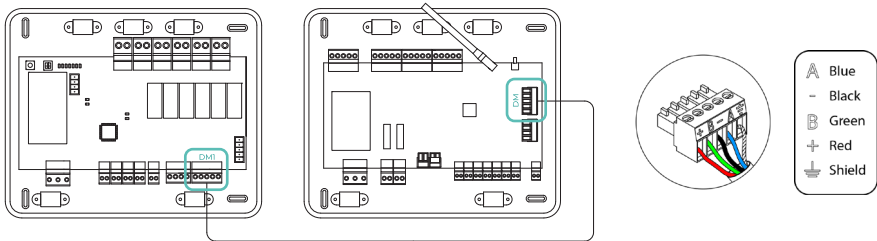

Note: Remember that, for this main control board to work correctly, all the main control boards in the installation must be addressed (up to 32 systems) (see System advanced settings section).

Integration bus (INT)

To connect to the bus, there is one 4-pin terminal for integration. Only available in configurations without webserver.

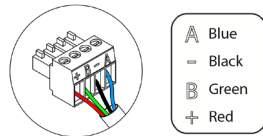

Digital inputs

The production control board is equipped with 4 digital inputs for external control of Airzone systems. These inputs are configured as normally open. For connection, the use of shielded cable is recommended.

- **DHW:** This input activates the DHW mode, whereby all systems that are working in air heating will stop and display the DHW message on the zone thermostats. This function is recommended for air to water installations when the air to water unit starts to produce DHW for the production of heating and air conditioning.
- **Heating:** This input activates the semi-forced heating mode in all the systems in the installation. It allows the selection of the modes: Stop, Heating and Ventilation.
- **Cooling:** This input activates the semi-forced cooling mode in all the systems in the installation. It allows the selection of the modes: Stop, Cooling, Dry and Ventilation.
- **Stop:** This input activates the Stop mode in all the systems in the installation.

Power supply (N L ⊕)

This connector supplies power to the production control board and consequently to the elements connected to it. External power supply at 110/230 VAC.

The power connection to the module is via a 3-pin terminal. Fix the cables with the screws on the terminal, following the color code.

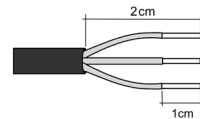
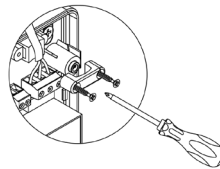
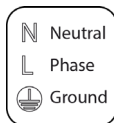
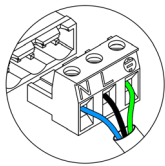

The connection to the external power supply must include a main switch or other method of disconnection that includes a constant separation for all polarities, in accordance with appropriate local and national regulations. The system will automatically restart if the power supply is turned off. **Use separate circuits for the unit that is to be controlled and the power supply to the system.**

Once all the connections have been made, make sure the cover of the main control board is correctly replaced.

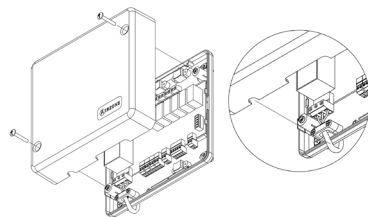

Airzone KNX integration gateway (AZX6KNXGTWAY)

For further information, see the [technical datasheet](#).

Assembly

This gateway is DIN rail mounted. It is powered by the main control board automation bus and the installation's KNX bus. The location and assembly of this module must comply with current electronic regulations.

Note: To remove the module, pull the tab downwards to release it.

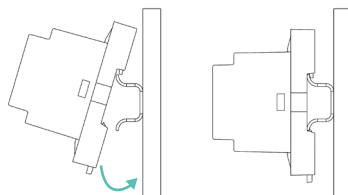

Connection



N°	Description
1	Automation bus
2	KNX bus
3	Programming

Automation bus

The Airzone-KNX integration gateway is connected to the automation bus on the main control board. To do this, there is one 5-pin terminal. Fix the cables with the screws on the terminal, following the color code.

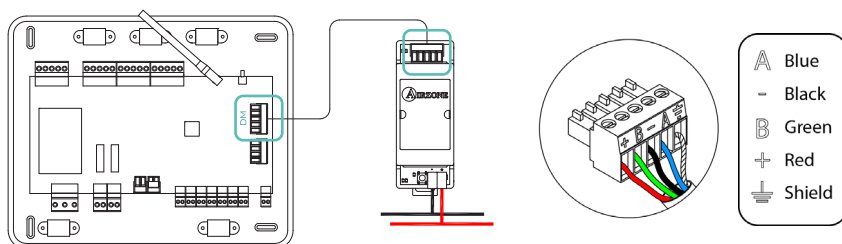

Important: Follow the polarity of the KNX bus: “-” pole black cable; “+” pole red cable.

Programming

To configure it, follow the steps described in the [KNX Installation Manual](#).

Airzone control gateway 3 speed Fancoil (AZX6FANCOILZ)

For further information, see the [technical datasheet](#).

Assembly

This device is DIN rail or wall mounted. This module is externally powered at 110/230 VAC. The location and assembly of this module must comply with current electronic regulations.

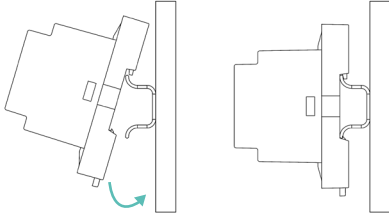

Mounted using DIN rail

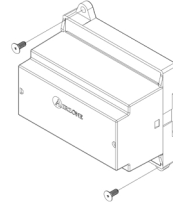

Mounted on wall

Note: To remove the module on DIN rail, pull the tab downwards to release it.

Connection

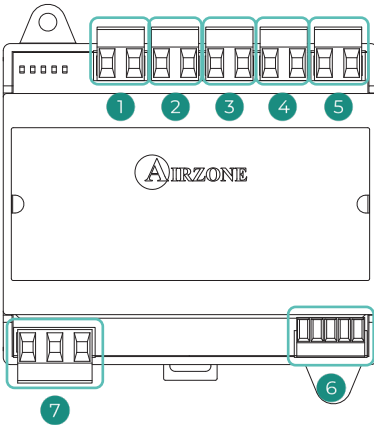

N°	Description
①	Air demand (cooling)
②	Speed 1
③	Speed 2
④	Speed 3
⑤	Air demand (heating)
⑥	AC unit bus
⑦	Power supply

Control relays

The characteristics of the control relays ①②③④⑤ are: I_{max} 10 A at 110/230 VAC voltage free. To control higher power elements, the use of contactors of the power to be controlled is recommended.

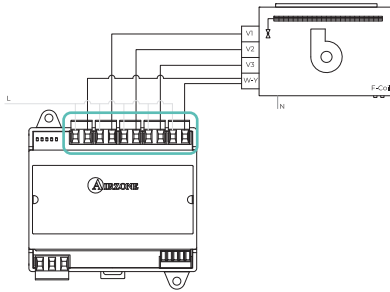

2-pipe installation

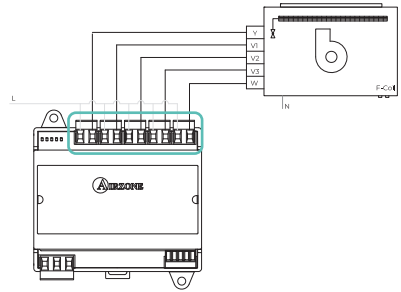

4-pipe installation

AC unit bus

For connection to the main control board AC unit bus there is one 4-pin terminal. Fix the cables with the screws on the terminal, following the color code. Only use the shield on the connector on the main control board side.

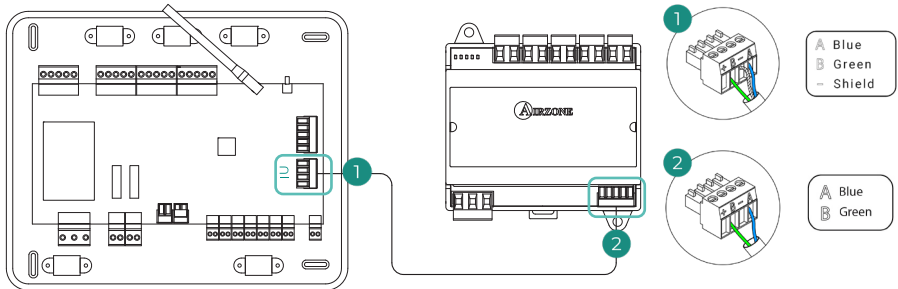

Power supply (N L ⊕)

The gateway is externally powered at 110/230 VAC. The power connection to the module is via a 3-pin terminal. Fix the cables with the screws on the terminal, following the polarity.

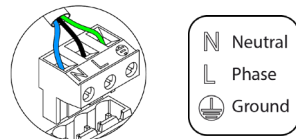

The connection to the external power supply must include a main switch or other method of disconnection that includes a constant separation for all polarities, in accordance with appropriate local and national regulations. The system will automatically restart if the power supply is turned off. **Use separate circuits for the unit that is to be controlled and the power supply to the system.**

Airzone control gateway 0-10 V Fancoil (AZX6010VOLT5Z)

For further information, see the [technical datasheet](#).

Assembly

This device is DIN rail or wall mounted. This module is externally powered at 110/230 VAC. The location and assembly of this module must comply with current electronic regulations.

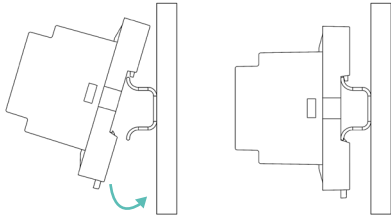

Mounted using DIN rail

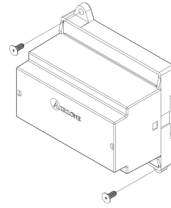

Mounted on wall

Note: To remove the module on DIN rail, pull the tab downwards to release it.

Connection

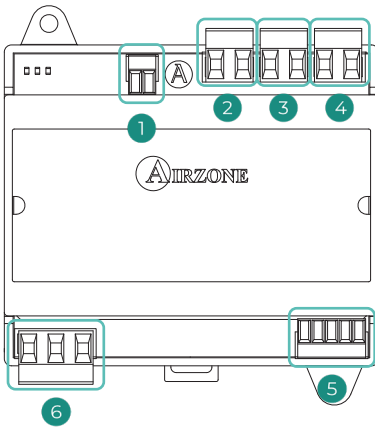

N°	Description
①	Fan control
②	Air demand (cooling)
③	Air demand (heating)
④	Ventilation demand
⑤	AC unit bus
⑥	Power supply

Control relays

The characteristics of the control relays ②③④ are: I_{max} 10 A at 110/230 VAC voltage free. To control higher power elements, the use of contactors of the power to be controlled is recommended.

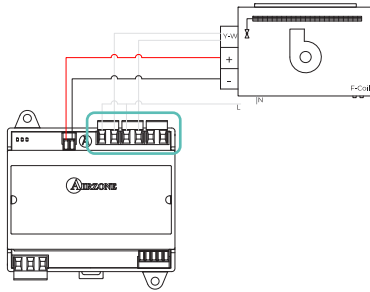

2-pipe installation

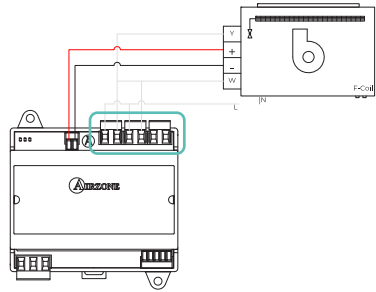

4-pipe installation

AC unit bus

For connection to the main control board AC unit bus there is one 4-pin terminal. Fix the cables with the screws on the terminal, following the color code. Only use the shield on the connector on the main control board side.

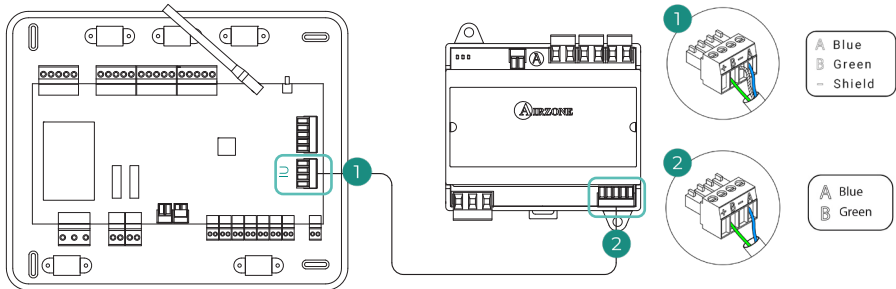

Power supply (N L ⊕)

The gateway is externally powered at 110/230 VAC. The power connection to the module is via a 3-pin terminal. Fix the cables with the screws on the terminal, following the polarity.

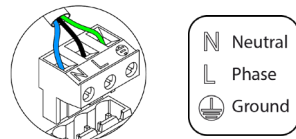

The connection to the external power supply must include a main switch or other method of disconnection that includes a constant separation for all polarities, in accordance with appropriate local and national regulations. The system will automatically restart if the power supply is turned off. **Use separate circuits for the unit that is to be controlled and the power supply to the system.**

Airzone control gateway electromechanical unit (AZX6ELECTROMECH)

For further information, see the [technical datasheet](#).

Assembly

This device is DIN rail or wall mounted. This module is externally powered at 110/230 VAC. The location and assembly of this module must comply with current electronic regulations.

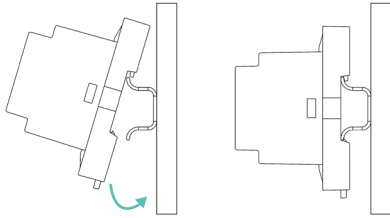

Mounted using DIN rail

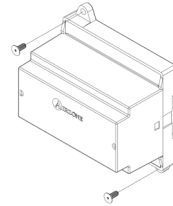

Mounted on wall

Note: To remove the module on DIN rail, pull the tab downwards to release it.

Connection

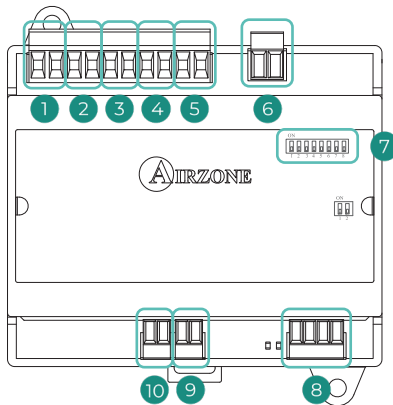

N°	Description
①	Heating mode
②	Ventilation mode
③	Compressor 2
④	Compressor 1
⑤	Cooling mode
⑥	Boiler
⑦	Microswitch
⑧	AC unit bus
⑨	Boiler probe
⑩	Unit probe

Control relays

The characteristics of the control relays ①②③④⑤ are: 24/48 VAC voltage free. To control higher power elements, the use of contactors of the power to be controlled is recommended.



The operation logic of the relays is as follows:

Mode	Demand	Control relays					
		0 - W	0 - V	0 - G2	0 - G1	0 - Y	C1 - 0
Stop	-	-	-	-	-	-	-
Ventilation	Yes	-	ON	-	-	-	-
	No	-	-	-	-	-	-
Cooling air (1 stage)	Yes	-	ON	-	ON*	ON	-
	No	-	-	-	-	ON	-
Cooling air (2 stages)	If return temp. < 28 °C	ON	ON	ON	ON	ON	-
	If return temp. > 28 °C	ON	ON	-	ON*	ON	-
	No	ON	-	-	-	ON	-
Heating air (1 stage)	Yes	ON	ON	ON	ON*	-	-
	No	ON	-	-	-	-	-
Heating air (2 stages)	If return temp. < 18 °C	ON	ON	ON	ON	-	-
	If return temp. > 18 °C	ON	ON	-	ON*	-	-
	No	ON	-	-	-	-	-
Radiant heating	Yes	ON	-	-	-	-	-
	No	ON	-	-	-	-	-
Combined heating	Dif. > Z °C	ON	ON	ON	ON	-	ON
	Dif. < Z °C	ON	-	-	-	-	ON
	No	ON	-	-	-	-	-

Note: The activation of compressor outputs (G2 and G1) alternates.

Microswitch

The operation logic of the microswitch is as follows:

Meaning		
	Compressor start up time	ON: 4 min
		OFF: 10 s
	Steady ventilation	ON: permanently On except when in Stop mode
		OFF: only if there is demand
	1 or 2 stage unit	ON: 2 stages
		OFF: 1 stage

AC unit bus

For connection to the main control board AC unit bus there is one 4-pin terminal. Fix the cables with the screws on the terminal, following the color code. Only use the shield on the connector on the main control board side.

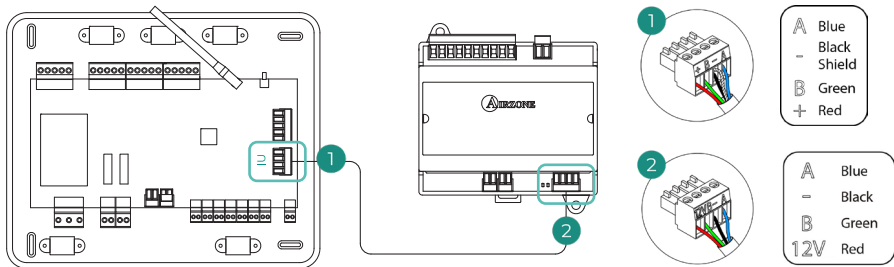

Clamp-on temperature probe (AZX6ACCTPA)

For further information, see the [technical datasheet](#).

Connects to the temperature probe (All) connector. Protects the AC unit from the water returning to the boiler.

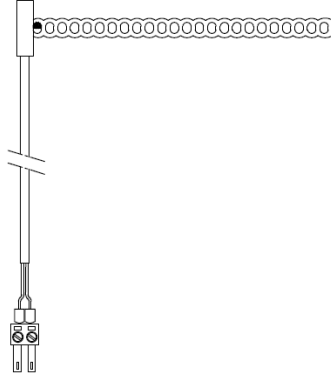

Temperature probe in sheath (AZX650NDPROTEC)

For further information, see the [technical datasheet](#).

Connects to the temperature probe (All) connector. Protects the AC unit from the water returning to the boiler.

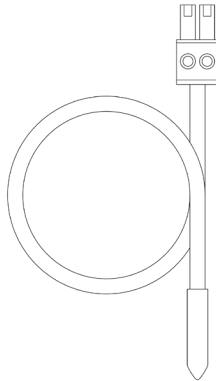

Plenum installation

The Easyzone 25 Plus Compact motorized plenum allows multiple separate ducts to be connected to a single AC unit, enabling individual air distribution to different zones within a building.

EASYZONE 25 PLUS COMPACT MOTORIZED PLENUM MEASUREMENTS

The Airzone motorized plenum (AZ1[C/H]25xn-Ø) includes:

- Easyzone 25 control unit (AZC25CB1IAQ), responsible for managing the system via wired and wireless devices.
- Motorised circular dampers (Ø150/200 mm, depending on configuration), with manual airflow adjustment.
- Climate zone management system and motorised damper control.
- Airzone Cloud Webserver (Wi-Fi or HUB depending on configuration) for remote monitoring and control via the Airzone Cloud App (AZX8WS1BWF / AZX6WSPHUB).
- Air purification system using ionisation integrated into the dampers.
- AirQ Sensor air quality sensor without VMC (AZAIQSNSOUT).
- Wi-Fi single-phase electricity consumption meter (AZX8AC1MTW1).

AZ1[C/H]25xn-Ø

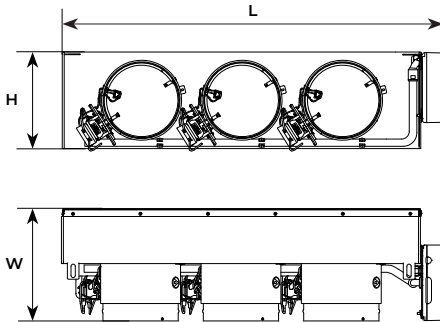

	n	(kg)	PLENUM (mm)			
			Ø	W	H	L
S	3	7±1.5	200	290.1	250	987.7
	4	7±1.5	150	290.1	250	987.7
M	4	9.5±1.5	200	290.1	250	1187.7
	5	9.5±1.5	150	290.1	250	1187.7
L	5	11.5±1.5	200	290.1	250	1487.7
	6	11.5±1.5	150	290.1	250	1487.7

AZ1[C/H]25xn-Ø
(MOTORIZED PLENUM)

x: S (Small), M (Medium), L (Large)
n: Number of dampers
Ø: Diameter (mm)

EASYZONE 25 PLUS COMPACT MECHANICAL ADAPTATION KIT

The Airzone motorized plenum is compatible with the Easyzone 25 Plus Compact mechanical adaptation kit (**AZEZOx[xxx][yy]**) (sold separately), which includes:

- Mechanical adapter collar with a custom geometry for ducted AC units
- Airzone control gateway (AZX8GTCxxx), in accordance with the required communication protocol.
- Mounting accessories.

AZEZOx[xxx][yy]

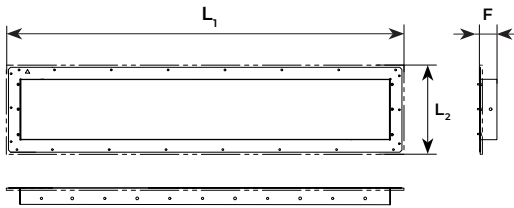

	n	ADAPTER COLLAR (mm)		
		L ₁	L ₂	F
S	3	920	240	100.8
	4	920	240	40
M	4	1120	240	100.8
	5	1120	240	40
L	5	1420	240	100.8
	6	1420	240	40

AZEZOx[xxx][yy]
(ADAPTER COLLAR+GATEWAY)

x: S (Small), M (Medium), L (Large)
[xxx]: Manufacturer
[yy]: Range

EASYZONE 25 PLUS COMPACT PLENUM ASSEMBLY

Installation on the indoor unit

It is recommended to insulate all metal parts of the Easyzone that remain in contact with the outside to prevent condensation.

1

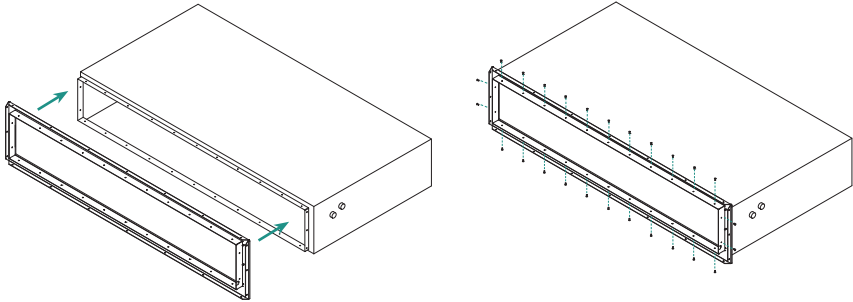

Place the adapter collar of the Easyzone motorized plenum on the unit's supply vent and fix it using the supplied screws.

Note: If the ducted unit has a front panel with circular adapters, remove it to fit the adapter collar supplied.

2

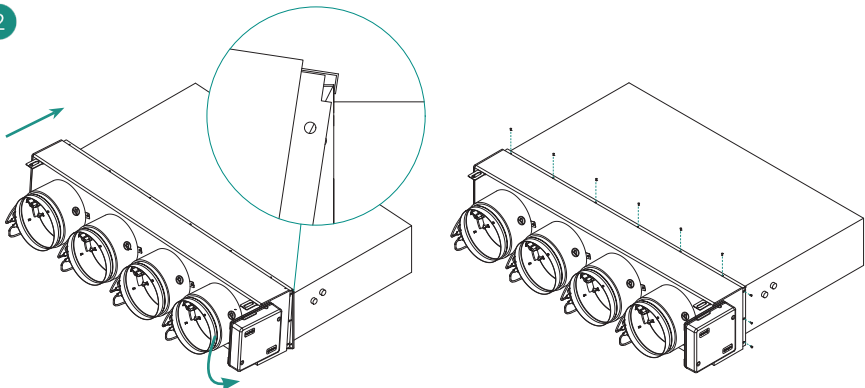

Position the Easyzone motorized plenum body and attach it to the previously installed collar using the supplied screws.

3

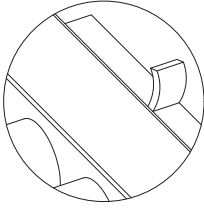

After attaching the motorized plenum to the adapter collar, make sure to insulate the connection between the two. Use insulation strips made of fiberglass or polyethylene foam, 0.98 inches (25 mm) thick.

4

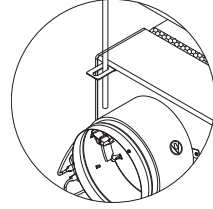

Use threaded rods to fix the motorized plenum to the ceiling through the tabs found at each end.

5

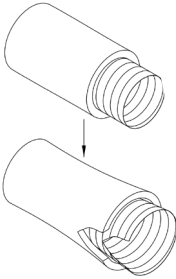

Make a cut at one end of the ducts you intend to use to keep the actuators accessible.

6

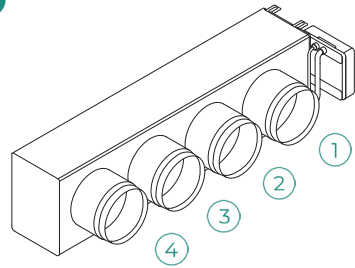

Fit each zone's duct to its corresponding damper in the order specified.

7

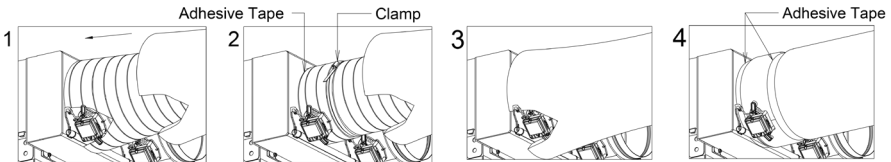

To ensure proper duct insulation, be sure to follow the provided instructions.

Damper override

1

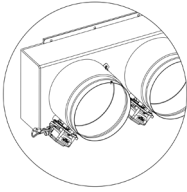

Ensure that the damper to be overridden is closed.

2

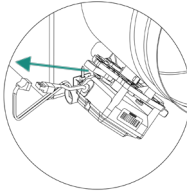

Disconnect the actuator.

3

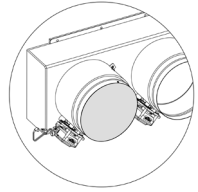

Insert the sealing cap on the damper.

Checking the installation

Check the following items:

1. LED status of the control elements connected. Consult the “Self-diagnostics” section on each element’s technical datasheet.
2. The main control board LED indicating the opening of motorized elements light up in sequence.
3. Power supply to wired and wireless thermostats.

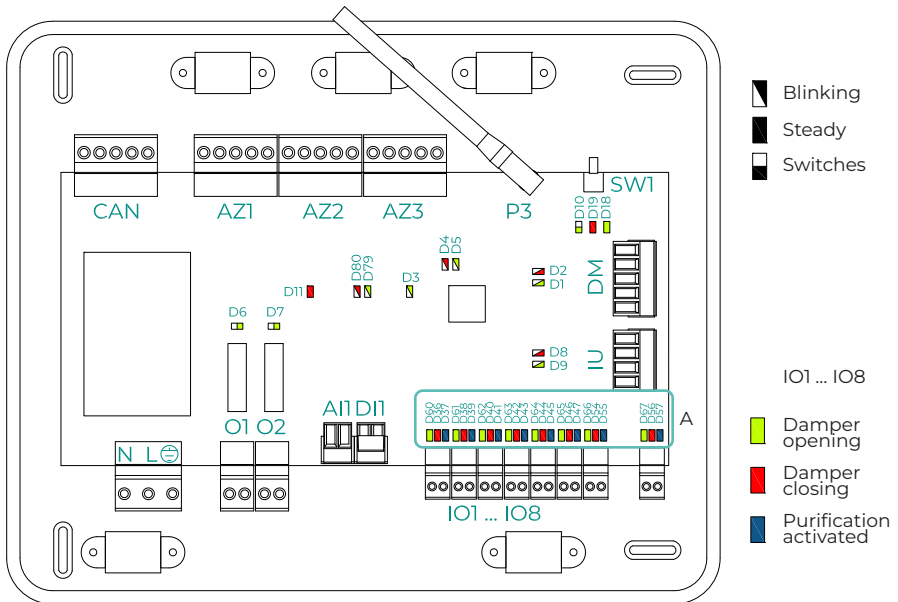

LED	Meaning	Status	Color
D1	Reception of data from the automation bus	Blinking	Green
D2	Transmission of data to the automation bus	Blinking	Red
D3	Main control board activity	Blinking	Green
D4	Transmission of data to the connection bus	Blinking	Red
D5	Reception of data from the connection bus	Blinking	Green
D6	AC unit On/Off	Switches	Green
D7	CMV/Boiler	Switches	Green
D8	Transmission of data to the AC unit bus	Blinking	Red
D9	Reception of data from the AC unit bus	Blinking	Green
D10	Reception of wireless packets	Switches	Green
D11	Power supply to main control board	Steady	Red
D18	Associated element	Steady	Green
D19	Association channel active	Steady	Red
D79	Reception of data from the CAN bus	Blinking	Green
D80	Transmission of data to the CAN bus	Blinking	Red
A	Open motorized elements	ON: Steady	Green
	Close motorized elements	ON: Steady	Red
	Purifier activated	ON: Steady	Blue

Initial configuration

AIRZONE BLUEFACE ZERO

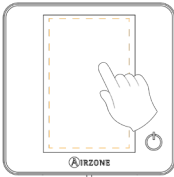

Languages:

- Spanish
- Italian
- English
- Portuguese
- French
- German

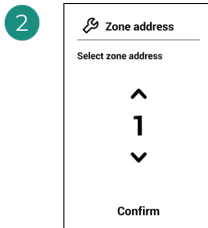

Select the zone associated to this thermostat.

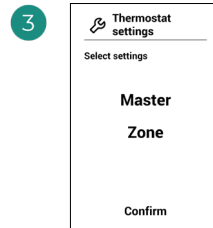

Master: Allows the control of all installation parameters.
Zone: Only allows the control of the zone parameters.

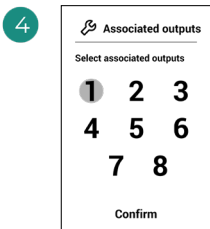

The system allows you to associate more than one control output to a zone if needed. It is therefore possible to manage several control outputs from a single thermostat. By default, the first free output will be selected. If no output is selected, the warning “Zone without associated outputs” will be displayed upon confirmation, allowing you to go back.

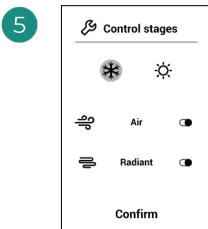

Stages to be controlled:

- Air
- Radiant
- Combined

If one of the stages is deactivated, the corresponding previously selected control output will be disabled.

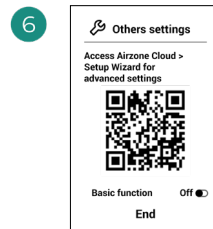

Finish the process. Access the setup Wizard for advanced settings from Airzone Cloud and/or activate the basic function (the latter allows on/off, speed setting, operation mode setting and temperature setting).

AIRZONE THINK

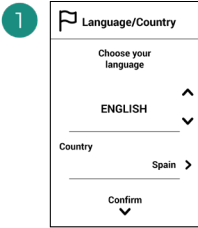
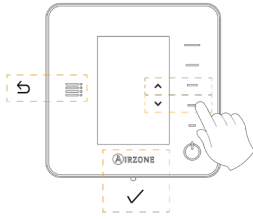

Languages:

- Spanish
- English
- French
- Italian
- Portuguese
- German

2

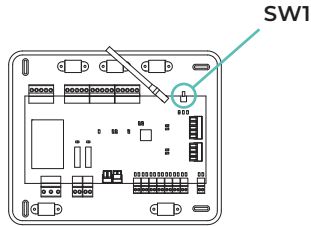

Wireless Think

Open the wireless association channel. To do so, click SW1. Once opened, you have 15 minutes to perform the association. You can also open the wireless association channel through the Blueface Zero thermostats.

IMPORTANT: Remember not to have more than one channel open in the same installation at the same time.

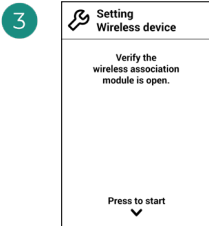

Start the search for the wireless channel.

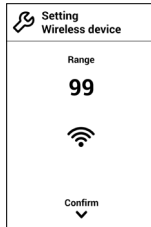

Check that the signal range is optimal (minimum 30%).

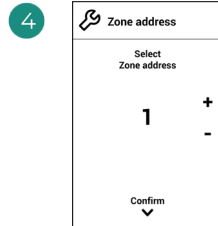

Select the zone associated to this thermostat.

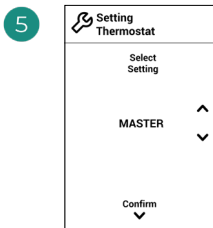

Master: Allows the control of all installation parameters.

Zone: Only allows the control of the zone parameters.

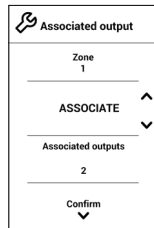
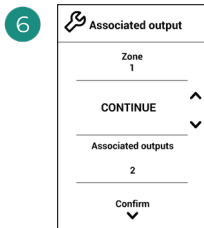

The system allows you to associate more than one control output to a zone if needed. It is therefore possible to manage several control outputs from a single thermostat. By default, the first free output will be selected. If no output is selected, the warning “Zone without associated outputs” will be displayed upon confirmation, allowing you to go back.

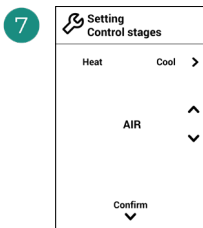

Stages to be controlled:

- Air
- Radiant
- Combined

If one of the stages is deactivated, the corresponding previously selected control output will be disabled.

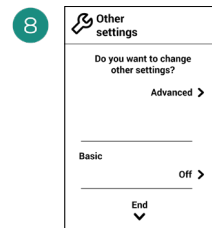

Finish the process. Access the setup Wizard for advanced settings from Airzone Cloud and/or activate the basic function (the latter allows on/off, speed setting, operation mode setting and temperature setting).

AIRZONE LITE



1

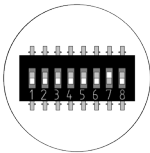
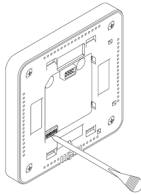

Select the zone associated to this thermostat by raising the microswitch corresponding to the zone.

3

Select other control outputs associated to the zone if necessary. This association must be carried out from the configuration wizard (through Airzone Cloud).

2

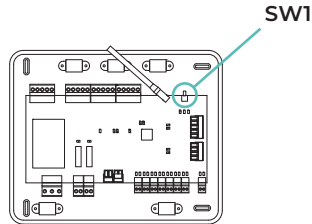

Wired Lite

Go to step 3.

Wireless Lite

Open the wireless association channel. To do so, click SW1. Once opened, you have 15 minutes to perform the association. You can also open the wireless association channel through the Blueface Zero thermostats.

IMPORTANT: Remember not to have more than one channel open in the same installation at the same time.

4

If you want to configure other thermostat settings you must access the zone advanced settings menu from an Airzone Blueface Zero thermostat.

The icon  will blink 5 times in green to indicate that the association is correct. If the icon blinks once in red, this indicates that the zone is occupied, and if it blinks twice in red, it means that the thermostat is not in signal range.

Remember: Should it be necessary to change the zone number, first reset the thermostat and initiate the association sequence.

CHECKING THE INITIAL CONFIGURATION

Check the following items:

1. **AC unit-system communication:** Set the Airzone system to an operation mode other than Stop and turn on the zone to generate demand. Verify that the mode imposed on the master thermostat appears on the indoor unit thermostat and that the set point temperature changes on the same.
2. **AC unit-system communication:** Set the Airzone system to Stop mode and verify that the AC unit turns off and dampers open.
3. **Opening/Closing of the dampers and/or control outputs:** Turn on and generate demand in all the zones. Then turn each zone off and on to check that the associated control outputs are correct.
4. Check that the **static pressure** in the ducted AC unit is in accordance with the conditions of the airflow distribution network in which it is installed (see the manufacturer's manual for the AC unit if you need to modify this parameter).

SYSTEM RESET

If you need to return the system to factory settings, press and hold **SW1** until **LED D19** stops blinking. Wait for the LED to return to their normal status and then repeat the initial configuration.

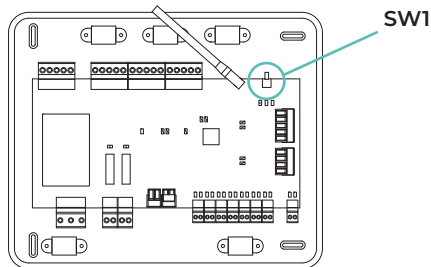

ZONE RESET

For Blueface Zero and Think thermostats, follow the steps indicated in the Advanced settings menu, Zone parameters.

For Lite thermostats, lower the zone microswitch and replace the thermostat in its base. The  icon will blink twice in green confirming that the reset has been completed.

Airflow regulation

Important: Start the airflow adjustment from the central dampers to the outer dampers.

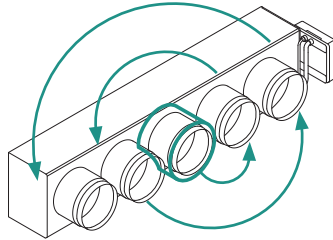

AIRFLOW ADJUSTMENT (REG)

1. Turn on and generate demand in all the zones to open all the dampers.
2. Turn off the zone/damper to be adjusted.
3. Adjust the desired maximum opening with the REG lever (I/II/III/IV).
4. Turn on the zone and verify that the airflow is correct.

MINIMUM AIR ADJUSTMENT (A-M)

1. Turn on and generate demand in all the zones to open all the dampers.
2. Turn on the zone/damper to be adjusted.
3. Adjust the desired minimum opening with the A-M lever (a/b/c/d).
4. Turn off the zone and verify that the minimum airflow is correct.

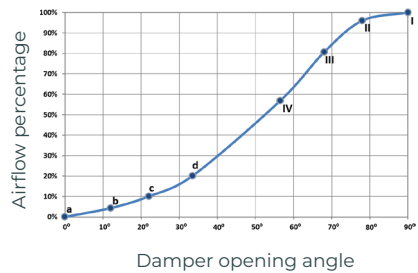
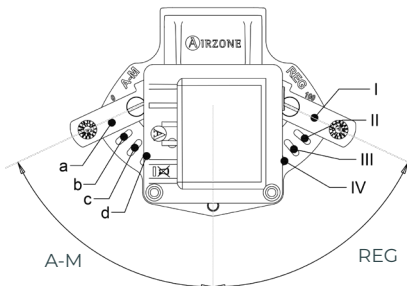

System advanced settings

AIRZONE BLUEFACE ZERO

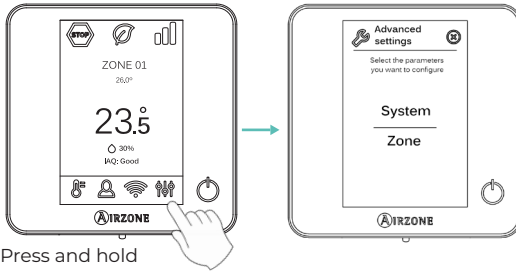

AIRZONE THINK

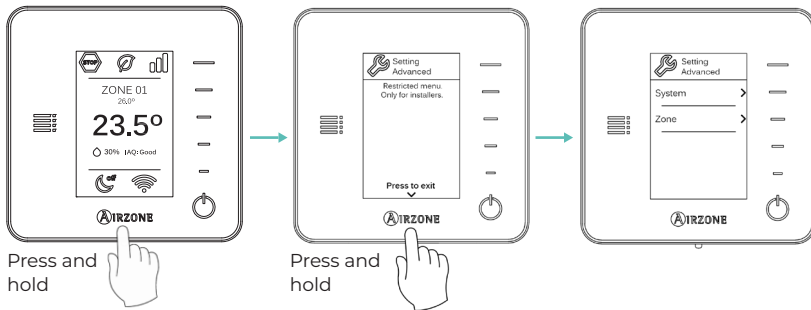

AIRZONE CLOUD

Advanced system configuration can be performed from the Airzone Cloud application (see Airtools section of the [Digital Support](#)).

The following parameters can be configured:

- System parameters
- Zone parameters
- Production parameters



SYSTEM PARAMETERS

System

- **Easyzone mode**¹. *(Only for Airzone Cloud)* Allows you to modify the behavior of the motorized elements when all zones are set to Off. This mode is enabled by default.
 - ◇ **Enabled:** all motorized elements remain open when the zones are set to Off.
 - ◇ **Disabled:** the last zone set to Off will keep the motorized element open for 4 minutes. After this time, all zones are kept closed.
- **Standby mode**¹. *(Only for Airzone Cloud and if "Easyzone mode" is enabled)* With this function activated, the unit remains switched on in low consumption mode once the cooling/heating demand has been met. The configuration options available are:
 - ◇ **Standby mode for cooling:** allows you to activate/deactivate Standby in cooling mode.
 - ◇ **Standby mode for heating:** allows you to activate/deactivate Standby in heating mode.
- **Standby hysteresis**¹. *(Only for Airzone Cloud and if "standby mode" is enabled)* Allows you to add a hysteresis value to the set point temperature applied by the system when Standby mode is activated (it is activated at 16 °C by default in Heating mode and at 30 °C in Cooling mode). The initial setting for hysteresis is 0 °C.
 - ◇ **Heating hysteresis:** sets a hysteresis value in heating mode (by default 3°C).
 - ◇ **Cooling hysteresis:** sets a hysteresis value in cooling mode (by default 1°C).
- **Radio channel.** This allows you to enable/disable the system's wireless association channel. If an AZCE8CM1VLAR module is connected, its association channel will also be opened.
- **Condensation protection**¹. *(Only in installations with AZCE8CM1VALC modules with cooling radiant controles zones)* Enables to select the protection level* against condensation: Very high, high, medium (by default), low and very low. If necessary, it can be activated for 1h.

**Note: In Very Low configuration, the humidifier (if one is installed) will be automatically activated if the relative humidity level is higher than 55% in any active zone.*
- **Humidity control**¹. *(Only available in installations with AZCE8CM1DRY modules)* Allows you to set a maximum humidity value* for all zones (default 50%) in steps of 5%.

**Note: The dehumidifier will automatically activate whenever the maximum humidity limit, plus 5%, of any active zone is exceeded. It will be deactivated when: no zone is above this value minus 5%, there are no active zones or it is switched to Stop mode.*

¹Parameters not available in Airzone Blueface Zero thermostats

- **Forced mode change¹.** *(Only available in installations with AZCE8CM1VALC modules)* Imposes the operation mode of the system according to the working mode of the centralized water production, detected through the digital input of the module. The options available are:

- ◇ Disabled (by default)
- ◇ Open: Forced heating. Closed: Forced cooling
- ◇ Open: Forced cooling. Closed: Forced heating

While forced mode change is enabled, it is possible to change the operation mode of the system, provided that it is compatible with the mode imposed by the production:

- ◇ Semi-forced cooling mode: can be changed to Ventilation / Dry / Stop mode.
- ◇ Semi-forced heating mode: can be changed to Ventilation / Stop mode.

In installations with AZX6CCPGAWI, forced mode inputs will have priority over this function.

- **Automatic mode change according to supply temperature*¹.** *(Only available in installations with AZCE8CM1VALC modules and with a temperature probe)* Imposes the operation mode of the system according to the supply temperature measured by the temperature probe of the module. The temperature limits that will determine the mode change must be configured:

- ◇ Cooling supply temperature: Value below which cooling mode will be imposed on the system. Range available: 10 - 21°C (by default, 18°C).
- ◇ Heating supply temperature: Value above which heating mode will be imposed on the system. Range available: 33 - 45°C (by default, 30°C).

While automatic mode change is enabled, it is possible to change the operation mode of the system, provided that it is compatible with the mode imposed by the temperature probe reading:

- ◇ Semi-forced cooling mode: can be changed to Ventilation / Dry / Stop mode.
- ◇ Semi-forced heating mode: can be changed to Ventilation / Stop mode.

In installations with AZX6CCPGAWI, forced mode inputs will have priority over this function.

**Note: The "Forced mode change" parameter must be set to "Disabled".*

- **Automatic time change¹.** *(Only for installations with Webserver)* Allows you to update the system time automatically. This parameter is disabled by default.
- **Filter maintenance warning¹.** *(Only for Airzone Cloud)* It is used to enable or disable the warning, edit hours of operation or reset the filter maintenance count.

¹Parameters not available in Airzone Blueface Zero thermostats

- **Centralized controller**¹. Enables bi-directional communication of all parameters of the AC unit with the Airzone system. By default, it will be disabled.
- **Protection mode**¹. (*Only for Airzone Cloud and installations with radiant stage in cooling mode*) This allows you to disable the delay in the closing of the motorized elements.

Stages¹

- **Cooling mode**. Allows you to select the minimum temperature for cooling mode (18 - 26 °C), in steps of 1 °C. By default, the minimum cooling temperature is set at 18 °C.
- **Combined cooling mode**. Allows you to enable the combined cooling stage.
- **Heating mode**. Allows you to select the maximum temperature for heating mode (19 - 30 °C), in steps of 1 °C. By default, the maximum heating temperature is set at 30 °C.
- **Combined heating mode**. Allows you to enable the combined heating stage.

Basic mode

- **Basic mode config**. Allows you to configure which parameters you want to display or control when selecting "Basic mode" as the thermostat use mode. The configuration options available are:
 - ◆ **Zone information**: displays/hides information related to the room temperature and humidity on both the main screen and the screensaver.
 - ◆ **Mode switching**: enables/disables the change of the operation mode.

Airflow

- **Q-Adapt**. (*Only in direct expansion installations*)
 1. **In direct expansion units**. This allows you to define the airflow control algorithm that best fits the duct installation. The options available are:
 - ◆ **Maximum**: the system operates at maximum speed regardless of the number of zones.
 - ◆ **Power**: the system operates at a higher speed than in Standard mode to ensure airflow is increased.
 - ◆ **Standard (by default)**: the system changes speed depending on the number of zones.
 - ◆ **Silence**: the system operates at a lower speed than in Standard mode to improve noise reduction.
 - ◆ **Minimum**: the system operates at minimum speed regardless of the number of zones.
 2. **In fancoil units 0-10V**. This allows you to set the minimum (1.5 V by default) and maximum (10 V by default) working voltage of the fan of the controlled AC unit, in 1 V steps. The minimum voltage will correspond to the desired minimum speed of the AC unit and the maximum voltage will correspond to the maximum speed. The average speed will correspond to the midpoint between the two.

¹Parameters not available in Airzone Blueface Zero thermostats

- **Proportional opening¹**. (Only in installations with AZCE8CBIMOT main control board) This allows you to enable/disable the proportionality of the system dampers. Proportionality scales the opening or closing of the damper in 4 steps according to the temperature demand of the zone, adjusting the zone airflow rate. By default, it is set to All/Nothing.

**Note: Changing this parameter affects all motorized dampers in the installation.*

Input/Output

- **Output O1**. This allows you to change the operation logic of the relay depending on the main control board version.

The configuration options available are as follows:

- ◆ High temp. circuit demand
- ◆ DHW (On/Off control visible from Airzone Cloud)
- ◆ CMV (On/Off control visible from Airzone Cloud)
- ◆ Manual control (On/Off control visible from Airzone Cloud)

If the output is configured as “High temp. circuit demand,” stage selection is enabled to activate relay O1 of the main control board. The available activation options are:

- ◆ Air
- ◆ Radiators
- ◆ Air and radiators

- **Output O2**. This allows you to change the operation logic of the relay depending on the main control board version.

The configuration options available are as follows:

- ◆ Low temp. circuit demand
- ◆ DHW (On/Off control visible from Airzone Cloud)
- ◆ CMV (On/Off control visible from Airzone Cloud)
- ◆ Manual control (On/Off control visible from Airzone Cloud)

If the output is configured as “Low temp. circuit demand,” stage selection is enabled to activate relay O2 of the main control board. The available activation options are:

- ◆ Floor
- ◆ Radiators*

**Note: This option is only available if Output O1 activation (when the operating logic is set to “High temp. circuit demand”) is configured as “Air.”*

- **Activation delay**. Allows you to select a delay time for the activation of the main control board’s relays, from 0 to 7 minutes. The default setting is 3 minutes.

¹Parameters not available in Airzone Blueface Zero thermostats

- **Input DI1**¹. (Only for Airzone Cloud) Allows you to modify the operation logic of the digital input. The configurations available are:
 - ◇ **Disabled**: keeps the alarm input disabled, so that no action is taken when opening/closing the contact.
 - ◇ **Alarm (NC) (by default)**: when an alarm warning is received, the Stop mode is set on the AC unit, so all system dampers are closed and the operation mode is blocked.
 - ◇ **Acoustic alarm (NC)***: alarm to connect the refrigerant leakage sensor (normally closed behavior). When the contact is opened, the “refrigerant leakage” error is activated.
 - ◇ **Acoustic alarm (NO)***: alarm to connect the refrigerant leakage sensor (normally open behavior). When the contact is closed, the “refrigerant leakage” error is activated.

**Note: If this alarm is activated, the “Silence alarm” parameter will appear in the Airtools Bluetooth information menu. This will stop the acoustic warning of the thermostats, but will not eliminate the error.*
- **Return temperature**¹. (Not available on AZCE6THINKR) (Only available in installations with AZX6SONDPROTEC/AZX6ACCTPA protection probe) This allows you to define the system's cut-off temperatures for the protection of the AC unit in heating mode (32 °C, 34 °C and 36 °C) and cooling mode (6 °C, 8 °C and 10 °C). By default, the system's heating cut-off temperature is set to 34 °C and the cooling cut-off temperature is set to 8 °C.

Cooling mode phases¹

- **Cooling mode phases**. (Only for Airzone Cloud and if there is an air stage in any of the zones) This allows you to define the phases that act in the Cooling Mode stages in order to carry out different combinations according to the needs of the system. The following phases are available:
 - ◇ **“Air only preparation” phase**: This allows you to initiate the “Cooling” phase only with the air stage until the selected differential between the room temperature and the set point temperature has been reached. Once this differential has been reached, the combined stage (air + radiant) is activated. This phase is only available and activated (by default) in systems with an air stage in any of their zones.
 - ◇ **“Cooling” phase**: This allows you to initiate the combined stage by configuring the activation/deactivation of the following parameters:
 - » **Air supply**: This enables the configuration of a temperature differential with respect to the set point temperature that marks the deactivation of the air stage. It will be available when there is an air stage in any zone. By default 0.5°C.

¹Parameters not available in Airzone Blueface Zero thermostats

Heating mode phases¹



















- **Heating mode phases.** *(Only for Airzone Cloud)* This allows you to define the phases that act in the Heating Mode stages in order to carry out different combinations according to the needs of the system. The following phases are available:
 - ◊ **“Air only preparation” phase:** *(Only available if there is an air stage in any of the zones)* This allows you to initiate the “Heating” phase only with the air stage until the selected differential between the room temperature and the set point temperature has been reached. Once this differential has been reached, the combined stage (air + radiant) is activated. This phase is only available and activated (by default) in systems with an air stage in any of their zones.
 - ◊ **“Heating” phase:** This allows you to initiate the combined stage by configuring the activation/deactivation of the following parameters:
 - » **Air supply:** *(Only available if there is an air stage in any of the zones)* This enables the configuration of a temperature differential with respect to the set point temperature that marks the deactivation of the air stage. It will be available when there is an air stage in any zone. By default 0.5°C.
 - » **Radiator supply:** *(Only available if there are radiators in any of the zones)* This enables the configuration of a temperature differential with respect to the set point temperature that marks the deactivation of the combined stage. It will be available when there are radiators in any zone. By default 0.5°C.

¹Parameters not available in Airzone Blueface Zero thermostats

Thermostat

- **System address.** (Not available on systems with Webserver configured as BACnet) This allows you to define the number of the system in your installation. By default, it displays the value 1. The system will show the free address values with a maximum value of 99.

If you have address 1 and have an Airzone production control board (AZX6CCPGAWI) in the installation, you can use the Supermaster function, which imposes the operation mode of system 1 on the other systems connected to the AZX6CCPGAWI in a semi-forced way:

Modo de funcionamiento del Sistema 1	Modos de funcionamiento disponibles del resto de Sistemas
	
	   
	   
	  
	 

- **Information.** This allows you to display information about:
 - ◆ **Zone:** firmware, zone, association, actuator or communications status.
 - ◆ **System:** firmware, IAQ firmware, settings and information on system and installation controllers.
 - ◆ **Devices:** indicates the elements connected to the system.
 - ◆ **Webserver:** firmware, IP address, gateway, MAC and PIN.
- **BACnet!** (Only in installations with Webserver configured as BACnet) This parameter shows the device ID, uplink port, IP address, subnet mask and gateway IP and allows you to modify them. Click on the desired value, modify the parameters and click on the option to confirm. The default values are:
 - ◆ Device ID: 1000
 - ◆ Port: 47808
 - ◆ IP address: DHCP
- **Reset system.** (Only available for Airzone Blueface Zero master thermostats) This allows you to reset the system by returning it to factory settings. To reconfigure the thermostats, go to the "Initial configuration" section.

ZONE PARAMETERS

HVAC

- **Basic mode.** This allows you to configure the thermostat for the system's different zones in Basic or Advanced mode. By default, it is set to Advanced. The parameters that can be controlled in "basic mode" are:
 - ◇ On/Off
 - ◇ Set point temperature
 - ◇ Operation mode (only if this is the master thermostat)

If a Lite thermostat is configured in "basic mode", no type of control will be permitted, acting only as a zone temperature probe. You can control this zone from Blueface Zero or Airzone Cloud.

If you need to reset the thermostat to "Advanced mode", access the advanced settings menu and activate "Advanced" use mode.

- **Master*.** This allows you to set up a thermostat as "Master" or "Zone".

**Note: It cannot be configured as Master if there is already another thermostat configured as such.*

- **Output configuration.** (Only for Airzone Cloud) This displays and allows you to select the control outputs associated to the thermostat.
- **Thermostat offset.** This allows you to correct the room temperature measured in the different zones or in all of them, due to deviations produced by sources of heat/cold nearby, with a correction factor between - 2.5 °C and 2.5 °C in steps of 0.5 °C. By default, it is set to 0 °C.

Thermostat

- **Control stages.** This allows you to configure the heating and cooling stages in the selected zone or all zones in the system. The options to configure are:
 - ◇ **Air:** enables heating/cooling by air in the zone selected.
 - ◇ **Radiant:** enables radiant heating/cooling in the zone selected.
 - ◇ **Combined:** enables air and radiant heating/cooling in the selected zone and allows the user to select the stage desired in that zone: Air, Radiant or Combined (see Zone settings section on the Blueface Zero thermostat, Stages).
 - ◇ **Off:** disables the heating/cooling stage in the zone selected.
- **Reset thermostat.** (Not available in remote zones) This allows you to reset the thermostat by returning to the initial settings menu.

IAQ¹

Only for Airzone Cloud and installations with AZX6AIQSNB.

- **Controlled mechanical ventilation.** Allows you to control a ventilation unit through the relay or the 0-10 V output. It is enabled by default.
 - ◇ **Steady ventilation*.** Allows you to act on the ventilation in the zone, regardless of whether it is in demand or not. If this parameter is enabled and the IAQ in the zone is "Good", ventilation will remain activated according to the value defined in Vmin. If it is disabled and the IAQ in the zone is "Good", ventilation will stop.
 - ◇ **Vmin/Vmax*.** Allows you to define the minimum and maximum voltage values for the 0-10 V output.

**Note: This option will be visible provided that the "Controlled mechanical ventilation" parameter is enabled.*
- **Humidity control*.** Allows you to activate the ventilation unit if the humidity limits established in the *Variables* section are exceeded. This is disabled by default.
 - ◇ **High humidity.** Ventilation will only be activated if the humidity value is above the upper limit of the range defined as "Good". This is disabled by default.
 - ◇ **Low humidity.** Ventilation will only be activated if the humidity value is below the lower limit of the range defined as "Good". This is enabled by default.

**Note: This option will be visible provided that the "Controlled mechanical ventilation" parameter is enabled.*
- **Variables.** Allows you to define the ranges and weights of the different variables available for the calculation of the IAQ index.
 - ◇ **Ranges.** Allows you to configure the "Good/Medium/Low" status limits for each variable according to the user's criteria.
 - ◇ **Weighting.** Allows you to select the weight of each variable in the calculation of the Indoor Air Quality index. The weight is selected in a drop-down menu with 10 % intervals from 0 % to 100 %. If a weight of 0 % is selected, the variable will not be taken into account in the calculation of the IAQ index. The default values are:
 - » Temperature (T°): Weight assigned by default 0 %.
 - » Relative humidity (RH): Weight assigned by default 0 %.
 - » CO₂ levels (CO₂): Weight assigned by default 80 %.
 - » Particles measuring less than 2.5 µm in diameter (PM_{2.5}): Weight assigned by default 30 %.
 - » Particles measuring less than 10 µm in diameter (PM₁₀): Weight assigned by default 30 %.
 - » Volatile organic compounds (TVOC): Weight assigned by default 20 %.
 - ◇ **Reset to default values.** Resets the default range and weight configuration.

¹Parameters not available in Airzone Blueface Zero thermostats

PRODUCTION PARAMETERS

Parameters available in installations with AZX6CCPGAWI. Control from Airzone Cloud.

- **Installation type.** This allows you to configure the operation logic of the control relays of the CCP:
 - ◇ Air-to-Water Heat Pump (by default)
 - ◇ 2 pipes
 - ◇ 4 pipes
 - ◇ Radiant
- **Activation delay.** This allows you to set a delay time in the power on of the production unit, configurable in minutes, from 0 to 7 minutes. The default setting is 3 minutes.
- **Water outlet temperatures.** (Only in installations with AZX8GAWXXX gateways) This allows you to set the water outlet temperatures for the heating and cooling modes of the aerothermal unit. Selectable values depends on each particular aerothermal unit. Default presets are:
 - ◇ Air in cooling mode: 10 °C
 - ◇ Radiant in cooling mode: 18 °C
 - ◇ Air/Radiator in heating mode: 50 °C
 - ◇ Radiant in heating mode: 35 °C
- **DHW function.** Allows you to configure the behavior of the system when there is production of DHW. By default it is enabled.
 - ◇ Enabled: It does not allow air demand alongside DHW production.
 - ◇ Disabled: It allows there to be air demand alongside DHW production.
- **Cooling mixing valve.** (Only in installations with AZX8GAWXXX gateways) Allows you to select the mode in which the dew point is calculated. Select "Auto" if you have mixing valves for cooling in your installation. It is set to "Manual" by default.
 - ◇ **Manual:** Adjusts the dew point to 19 °C.
 - ◇ **Auto:** Uses the cold water supply temperature to calculate the dew point.

Incidences

In the case of Airzone Blueface Zero and Think thermostats, a warning  will appear on the display screen.

WARNINGS

Anti-freezing. This is displayed if the function is enabled.

Active window. Indicates that the air conditioning has been suspended in the zone due to an open window. Only available in systems that have enabled the control of windows.

DHW. Domestic hot water activated. If your system integrates DHW management control in its production unit and this is activated, this message will appear on your Blueface Zero and the air conditioning in that zone will be suspended.

Active dew protection. It indicates there is a risk of condensation in the radiant stage and the air stage has been activated to avoid its creation.

Active dew. This alert warns of a risk of water condensation and the zone has been shut off, turning on the dehumidifier, if it has been installed. Only available in systems with radiant stages in cooling mode.

Dew protection Lite. *(Only in Blueface Zero thermostats)* It indicates there is a risk of condensation in the radiant stage and the air stage has been activated to avoid its creation in the Lite zone.

Dew Lite. *(Only in Blueface Zero thermostats)* It indicates there is a risk of condensation and the zone where the Lite thermostat is located has been turned off. Press the icon to know which zone is affected.

Humidity. *(Only in installations with module AZCE8CM1DRY)* This warning indicates that the maximum humidity has been exceeded in some zone and the dehumidifier has been activated.

Low battery. *(Only in Think wireless thermostats)* Low battery warning.

Battery Lite. *(Only in Blueface Zero thermostats)* Low battery warning. Informs about the involved zone when the icon is pressed.

Low valve battery. *(Only in installations with AZCE8CM1VALR modules)* Low battery warning for valve.

NTC2 alarm. Measurement error in the temperature probe.

Filter maintenance. This indicates that filter maintenance should be performed.

IAQ priority activated. Indicates that ventilation and ionization have been enabled because the measured particle level is medium or low.

Consumption meter not detected. *(Only for Airzone Cloud)* This warning indicates that the system requires a consumption meter, and none has been detected as linked/associated with the Airzone Cloud Site.

ERRORS

In the case of any of the following errors , please contact your installer:

Communication errors

- 1. Thermostat – Main control board
- 8. Lite thermostat – Main control board
- 9. Gateway – Airzone system
- 10. BACnet gateway – Main control board
- 11. Gateway – Indoor unit
- 12. Webserver – Airzone system
- 13. Control module of radiant elements – Main control board
- 17. Lutron gateway – Airzone system
- 18. Dehumidifier module – Main control board
- C-02. Production control board – Main control board
- C-09. Air to water gateway – Production control board
- C-11. Air to water gateway – Air to water unit
- V01. AZCE8CMIVALR module – Main control board
- V02. AZCE8CMIVALR module – AZX6AC1VALR head

AC unit error. Anomaly in the AC unit

AC unit error. Refrigerant leakage

Other errors

- 5. Open circuit in temperature probe
- 6. Short circuit in temperature probe
- 19. Alarm jumper error
- R05. Open circuit in Control module of radiant elements temperature probe
- R06. Short circuit in Control module of radiant elements temperature probe

Purification errors

- IAQ0. AirQ Sensor not detected
- IAQ1. Loss of communication between the ionization controller and the main control board
- IAQ3. Zone module with ionization not connected
- IAQ4. Actuator connected directly without ionizer
- IAQ7. Loss of communication between the AirQ Sensor and the main control board

Lite errors

In the case of Airzone Lite thermostats, if the On/Off icon  blinks rapidly in red, it means communication with the main control board has been lost.

Error 1. Thermostat (Wired) - Main control board

This issue does not allow the zone to be controlled. Check whether the error appears on all thermostats; if it does, check that the main control board is operating properly. To resolve this issue, make the following checks:

1. Main control board status: Check that the power supply is correct.
2. Main control board status: Correct operation of the Airzone connection bus LED.
3. Connections: Check that the polarity of the connections to the main control board and the thermostat is correct.
4. Wiring: Check that the voltage between poles (A/-) and (B/-) is 1.8 VDC.
5. Restart the zone and reassociate it to the system:
 - Blueface Zero thermostats: Press on the word Reset to restart the device. If the error persists, press and hold the icon and reset the thermostat. Carry out the initial configuration of the system.
 - Think thermostats: Press and hold on **AIRZONE** and perform the initial system configuration process.
6. Restart the system: If you restart the system, this error may appear on the thermostats due to the restart. This message should disappear in approximately 30 seconds once the restart has been completed.

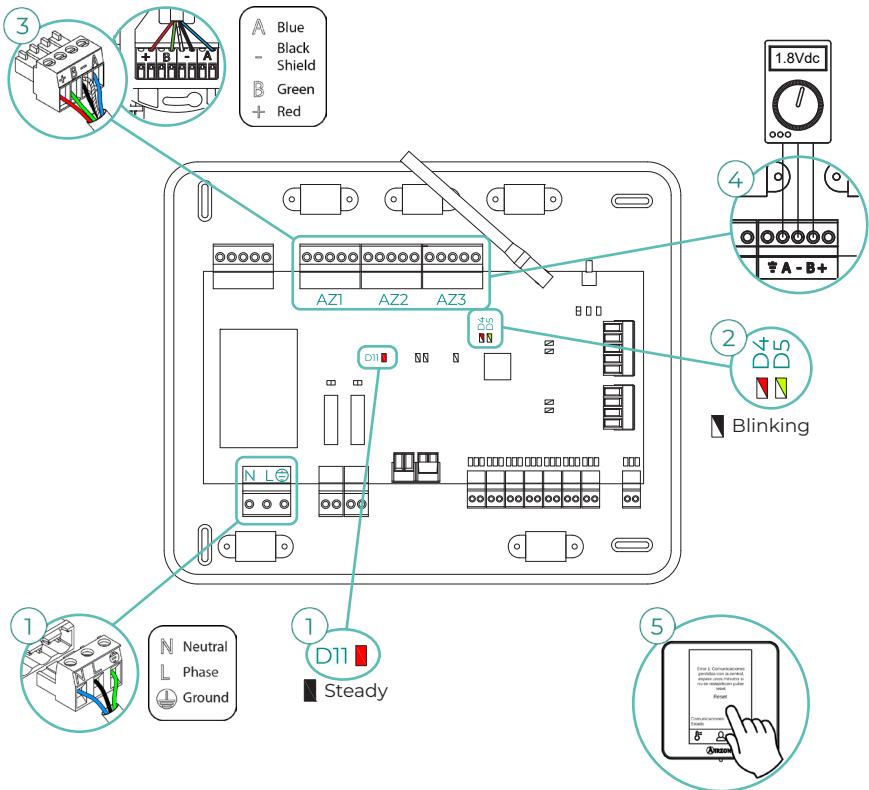

Error 1. Thermostat (Wireless) - Main control board

This issue does not allow the zone to be controlled. Check whether the error appears on all thermostats; if it does, check that the main control board is operating properly. To resolve this issue, make the following checks:

1. Thermostat status: Check the thermostat's signal range from the main control board by checking the Information parameter (see the section System advanced settings, System parameters), or by bringing the thermostat closer to the main control board. If it re-establishes communication, it will be necessary to relocate the thermostat because it was not in signal range.
2. Main control board status: Check that the power supply is correct.
3. Main control board status: Check the correct functioning of the wireless communication LED.
4. Restart the zone and reassociate it to the system. To do this, press and hold on **AIRZONE** and perform the initial system configuration process. Remember that, in order to associate wireless devices, you should first open the wireless association channel, either through the SW1 button on the main control board or from any thermostat in the Radio channel parameter of the System advanced settings menu, Zone parameters.
5. Restart the system: If you restart the system, this error may appear on the thermostats due to the restart. This message should disappear in approximately 30 seconds once the restart has been completed.

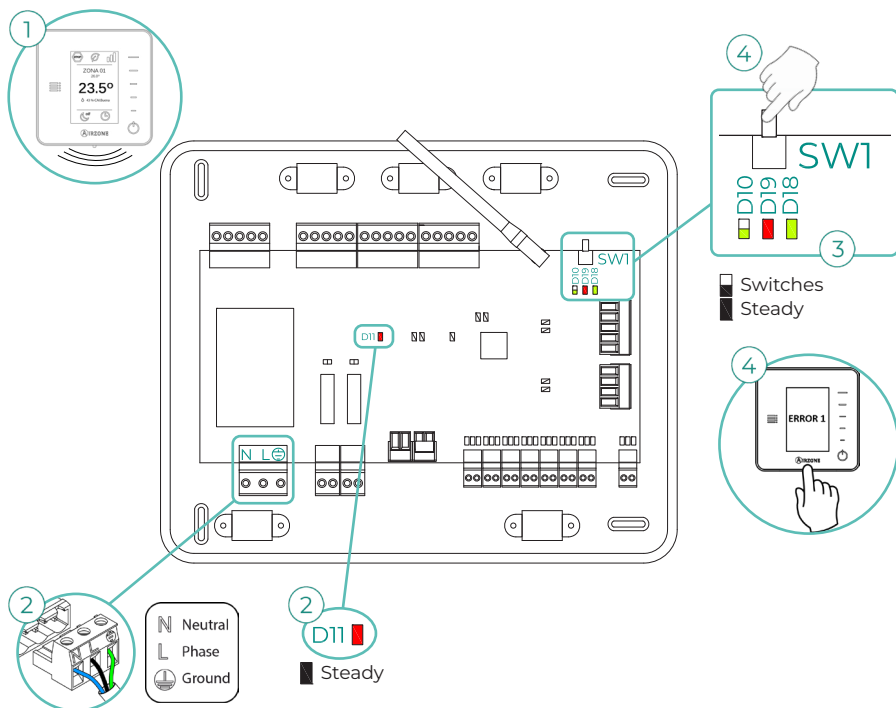

Error 5. Open circuit in temperature probe

The zone loses the room temperature measurement, leaving the zone unable to generate demand. In the event of such an incident, the device must be replaced or sent for repair.

Error 6. Short circuit in temperature probe

The zone loses the room temperature measurement, leaving the zone unable to generate demand. In the event of such an incident, the device must be replaced or sent for repair.

Error 8. Lite thermostat (Wired) - Main control board

The zone loses the room temperature measurement of an associated wired Lite thermostat, leaving the zone disabled and unable to generate demand. From your Blueface Zero thermostat, check whether the Lite thermostat has lost communications. To resolve this issue, make the following checks:

1. Connections: Check that the polarity of the connections to the main control board and the sensor is correct.
2. Wiring: Check that the voltage between poles (A/-) and (B/-) is 1.8 VDC.
3. Check whether the thermostat in question has the microswitch that corresponds to the associated zone selected. If not, activate it by pulling up the switch to the desired value.

Remember: Should it be necessary to change the zone number, first reset the thermostat and initiate the association sequence.

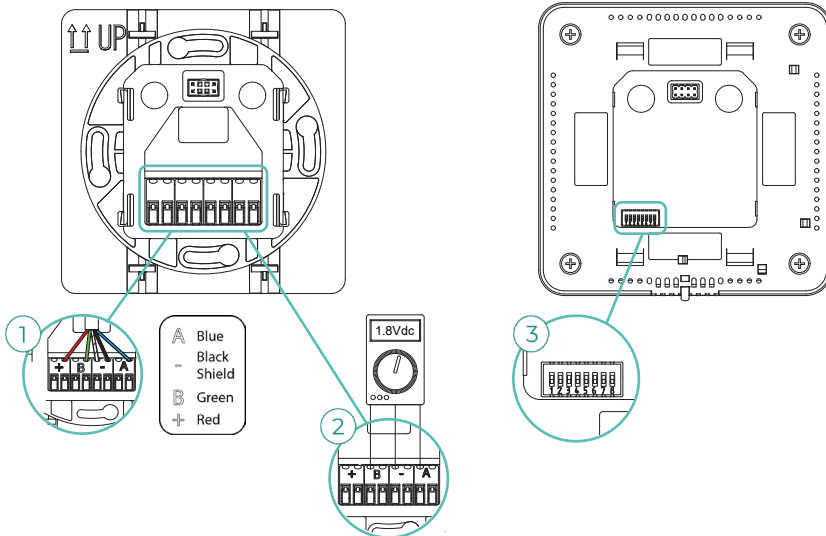

Error 8. Lite thermostat (Wireless) - Main control board

The zone loses the room temperature measurement of an associated wireless Lite thermostat, leaving the zone disabled and unable to generate demand. From your Blueface Zero thermostat, check whether the Lite thermostat has lost communications. To resolve this issue, make the following checks:

1. Power supply: Check the battery's status and, if in doubt, replace it with a new battery.
2. Check whether the Lite thermostat in question has the microswitch that corresponds to the associated zone selected. If not, activate it by pulling up the switch to the desired value. Remember that, in order to associate wireless devices, you should first open the wireless association channel, either through the SW1 button on the main control board or from any thermostat in the Radio channel parameter of the System advanced settings menu, Zone parameters.

Remember: Should it be necessary to change the zone number, first reset the thermostat and initiate the association sequence.

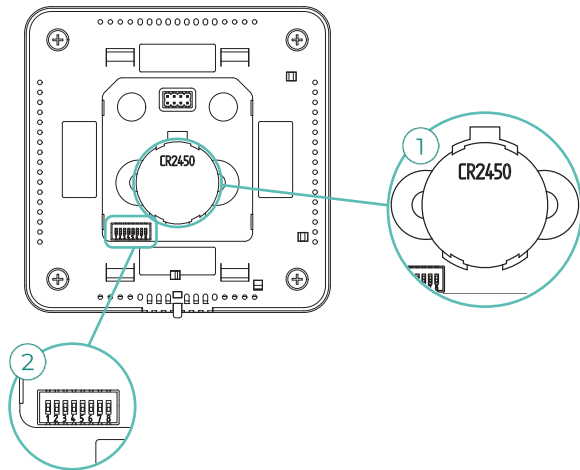

Error 9. Gateway - Airzone system

The system loses communication with the gateway and therefore with the AC unit. The system will open all its zones and disable control from the system's thermostats, thus allowing the AC unit to operate from the manufacturer's thermostat. To resolve this issue, make the following checks:

1. That the gateway is properly connected to the main control board's IU port.
2. If the gateway is a DIN rail format, check that the polarity of the connectors of the gateway and the main control board's IU port is correct.
3. Check that the status of the connected gateway's LED is correct. To do so, make use of the troubleshooting section or your gateway's technical fact sheet.

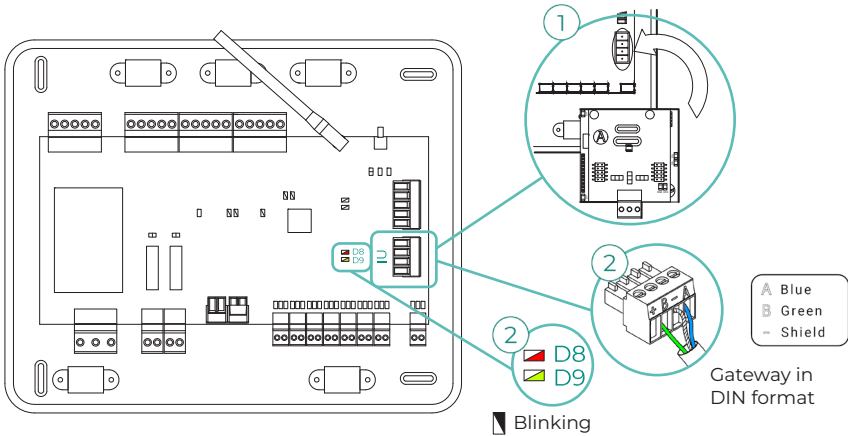

Error 10. BACnet gateway - Main control board

Webserver configured as BACnet

The system loses communication with the Webserver. Check that the Webserver is properly connected to the main control board's automation port (DM1).

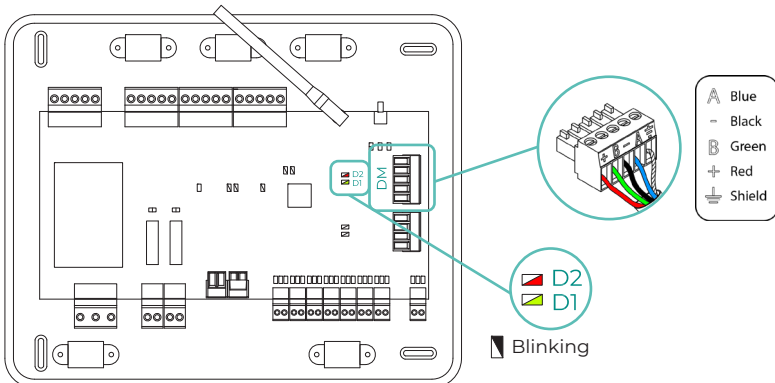

Error 11. Gateway - Indoor unit

The gateway loses communication with the AC unit. The system will open all its zones and disable control from the system's thermostats, thus allowing the AC unit to operate from the manufacturer's thermostat. To resolve this issue, make the following checks:

1. That the AC unit is powered. To do this, check that the AC unit's thermostat is switched on.
2. Check whether the AC unit operates properly independently of the system. To do so, disconnect the AC unit from the Airzone system and activate the unit from the AC unit's thermostat.
3. Connections: Check that the polarity of the connections to the gateway and indoor unit is correct. Consult your gateway's technical fact sheet.
4. Check that the status of the connected gateway's LED is correct. To do so, make use of the troubleshooting section or your gateway's technical fact sheet.

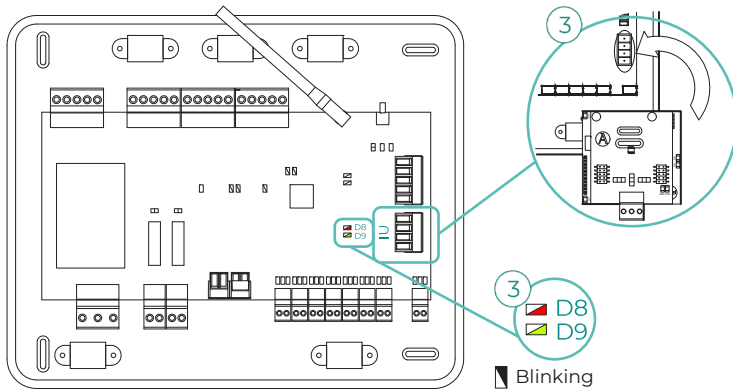

Error 12. Webserver - Airzone system

The system loses communication with the Webserver. To resolve this issue, make the following checks:

1. Check that the Webserver is properly connected to the main control board's automation port.
2. Check that the polarity of the connectors of the Webserver and the main control board's automation port is correct.
3. Check that the status of the Webserver's LED is correct. To do so, make use of your Webserver's self-diagnostics section or technical fact sheet.

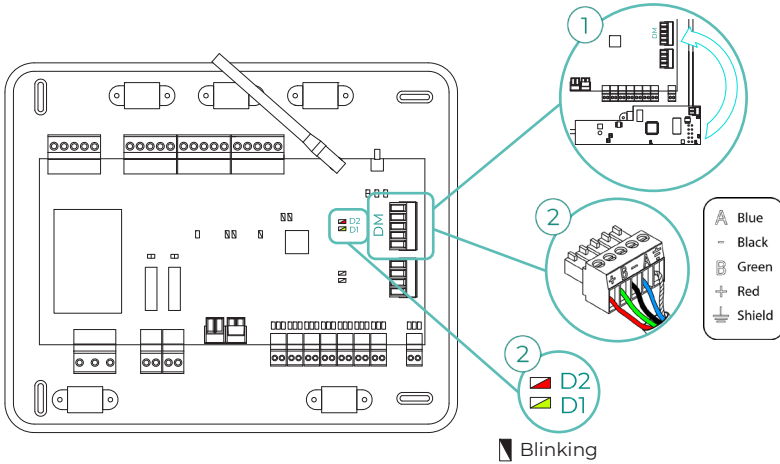

Error 13. Control module of radiant elements - Main control board

This issue does not allow the system to control the device. To resolve this issue, make the following checks:

1. Control module of radiant elements status: Check that the power supply is correct.
2. Control module of radiant elements and main control board status: Correct operation of the CAN bus LED.
3. Connections: Check that the polarity of the connections to the main control board and the control module of radiant elements is correct.
4. Wiring: Check that the voltage between poles (A/-) and (B/-) is 1.8 VDC.

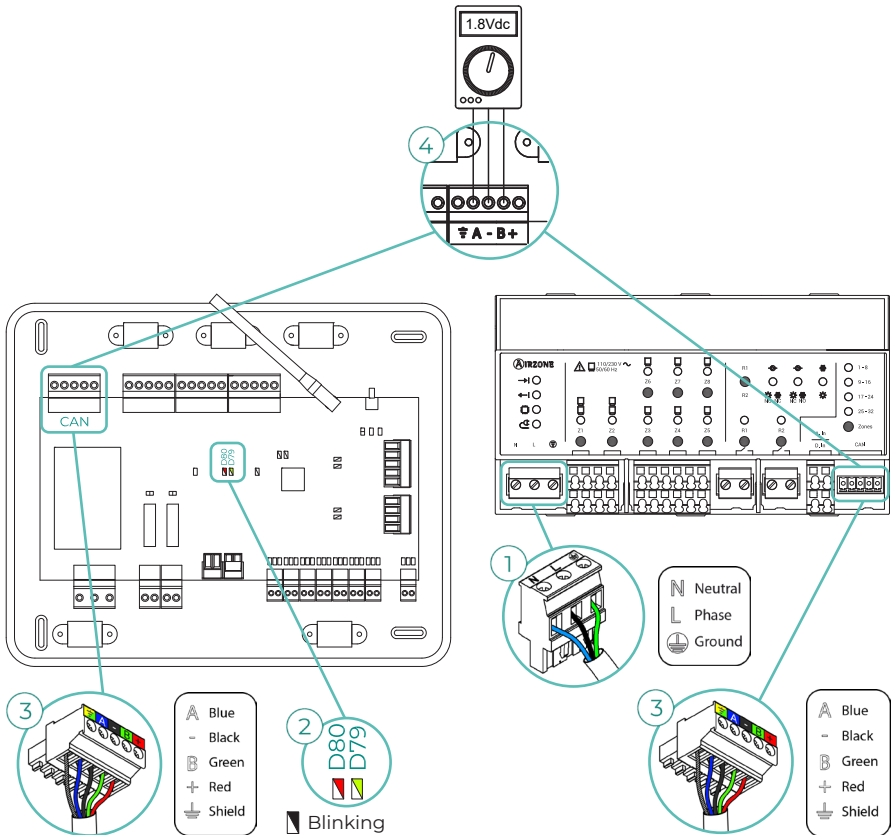

Error 17. Lutron gateway - Airzone system

Webserver configured as Lutron

The system loses communication with the Webserver. Check that the Webserver is properly connected to the main control board's automation port (DM1).

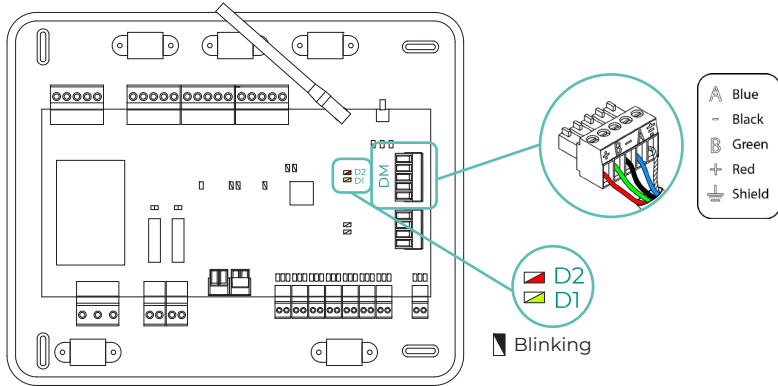

Error 18. Dehumidifier module - Main control board

This issue does not allow the system to control the device. To resolve this issue, make the following checks:

1. Dehumidifier module status: Check that the power supply is correct.
2. Dehumidifier module and main control board status: Correct operation of the CAN bus LED.
3. Connection: Check that the polarity of the connections to the main control board and the dehumidifier module is correct.
4. Wiring: Check that the voltage between the poles (A/-) and (B/-) is about 0.65 VDC.

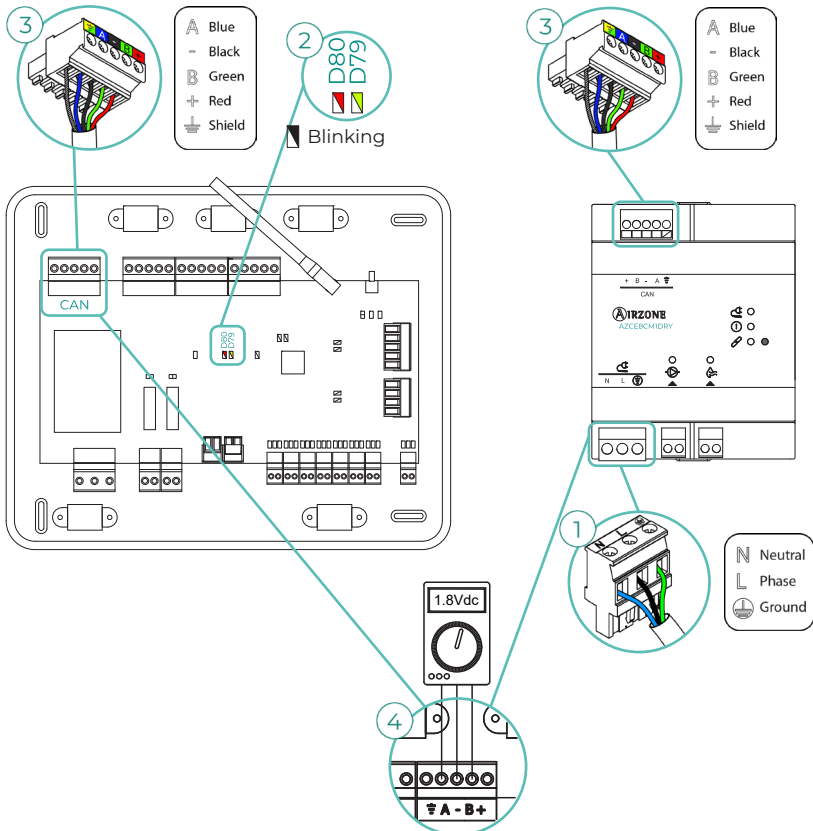

Error 19. Alarm jumper error

The system detects that the alarm jumper is not connected and forces it into Stop mode. Check to be sure that the alarm jumper is properly connected.

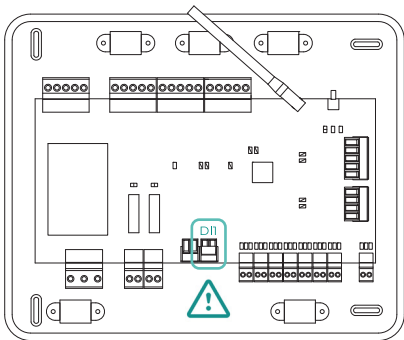

Error C-02. Production control board - Main control board

This issue does not allow the zone to be controlled. To resolve this issue, make the following checks:

1. CCP status: Check that the power supply is correct.
2. Status of the main control board: Check the correct functioning of the automation bus LED.
3. Connections: Check that the polarity of the connections to the CCP and the main control board are correct.

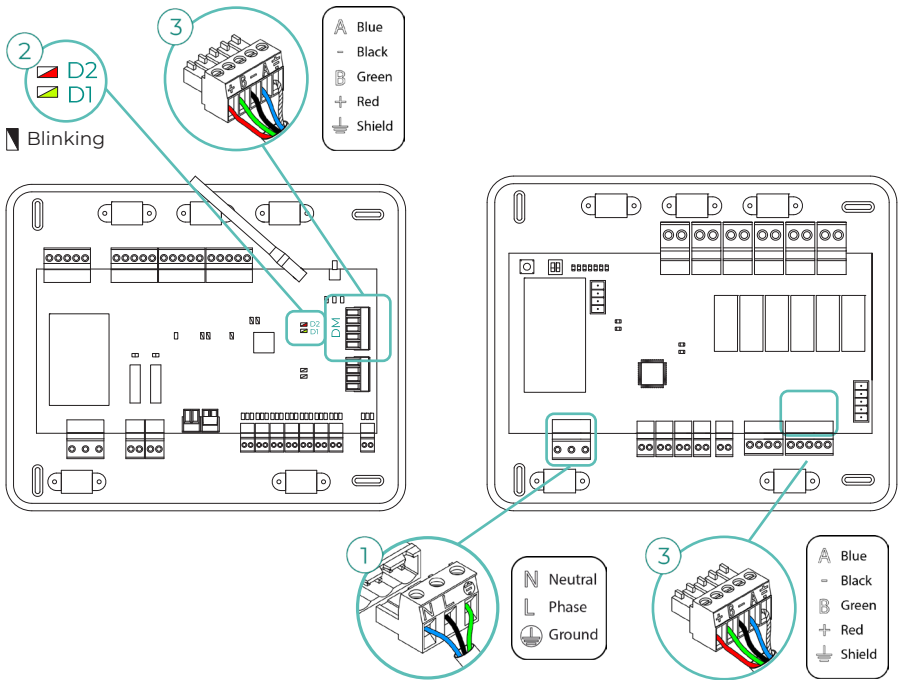

Error C-09. Air to water gateway - Production control board

The gateway loses communication with the air to water unit. Control of the system will be disabled, thus allowing the air to water unit to operate from the manufacturer's thermostat. To resolve this issue, make the following checks:

1. Check that the gateway is properly connected to the production control board's AC unit port.
2. Check that the status of the connected gateway's LED is correct. To do so, make use of the troubleshooting section of your gateway's technical fact sheet.

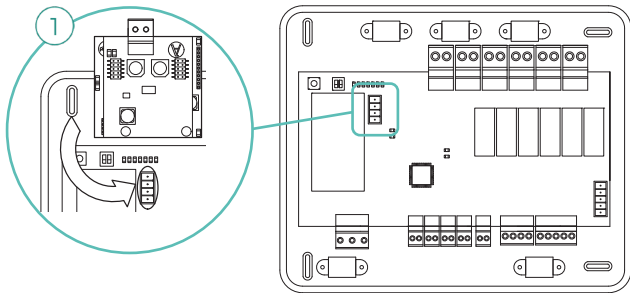

Error C-011. Air to water gateway - Air to water unit

The gateway loses communication with the air to water unit. Control of the system will be disabled, thus allowing the air to water unit to operate from the manufacturer's thermostat. To resolve this issue, check that the gateway is properly connected to the CCP's automation bus and the connection between it and the indoor unit. For more information on the connection between your gateway and the indoor unit, refer to your gateway's data sheet.

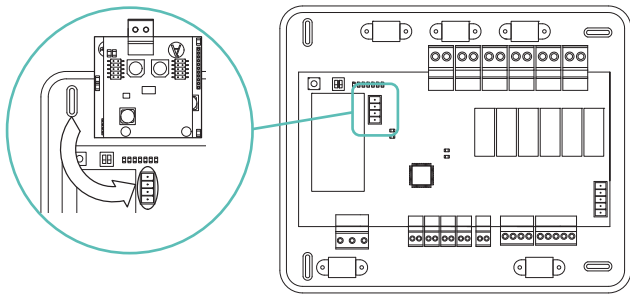

Error R05. Open circuit in Control module of radiant elements temperature probe

The system loses the temperature measurement of the radiant manifold. Proceed to replace it of the device or sent it for repair.

Error R06. Short circuit in Control module of radiant elements temperature probe

The system loses the temperature measurement of the radiant manifold. Proceed to replace it of the device or sent it for repair.

Error V01. AZCE8CMIVALR module - Main control board

This issue does not allow the system to control the device. To resolve this issue, make the following checks:

1. AZCE8CMIVALR module and main control board status: Correct operation of the CAN bus LED.
2. Connection: Check that the polarity of the connections to the main control board and the module is correct.
3. Wiring: Check that the voltage between the poles (A/-) and (B/-) is about 1 VDC.

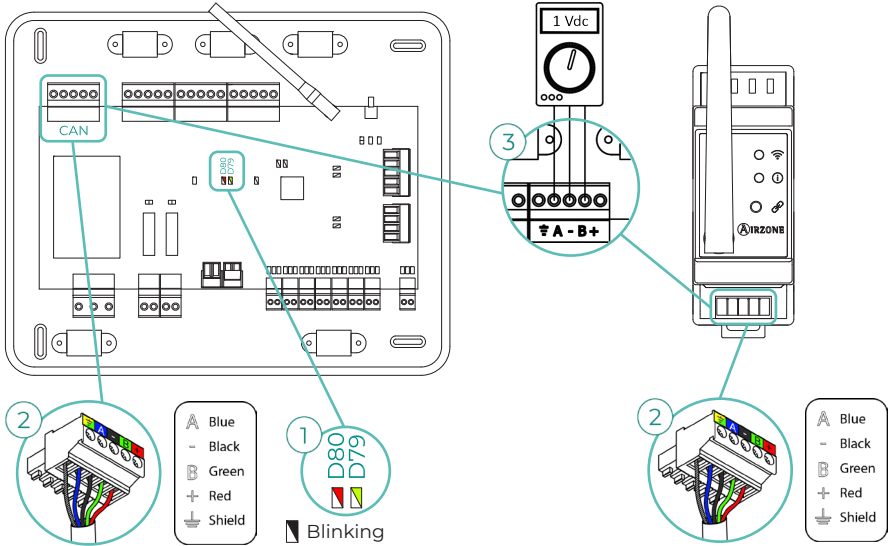

Error V02. AZCE8CMIVALR module - AZX6ACTIVALR head

This issue does not allow the system to control the device. To resolve this issue, make the following checks:

1. Communication between AZCE8CMIVALR module and AZX6ACTIVALR head.
2. Appropriate distance to ensure signal range between head and module. Maximum distance in open space: 40 m.

Error IAQ0. AirQ Sensor not detected

This warning indicates that the AirQ Sensor has not been detected and, therefore, Indoor Air Quality cannot be measured. Once an AirQ Sensor is connected, the error disappears.

Error IAQ1. Loss of communication between the ionization controller and the main control board

This error occurs when synchronization or communication between the ionization controller and the main control board is lost. It disappears after the communication is recovered.

Error IAQ3. Zone module with ionizer not connected

This warning indicates that an ionizer has not been detected in a zone and is generated when ionization is started in a zone. To resolve this issue:

1. Check that the polarity of the connections between the IOx port and the Ionizer is correct.
2. Check the ionization status LED on the main control board.

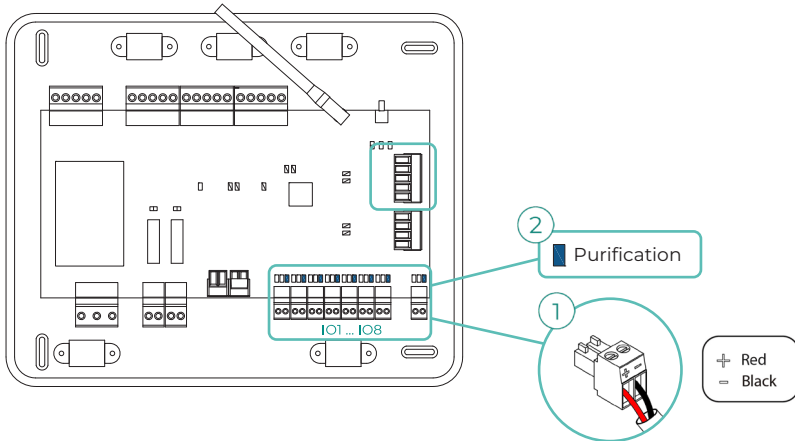

Error IAQ4. Actuator connected directly without ionizer

This error occurs when an actuator is directly connected to the outputs intended for the ionization boards on the main control board. It can cause the actuators to stop running.

If you reset the system, the error will become IAQ3 and will allow ionization in all zones except this one.

You can resolve this issue by following the steps below:

1. Check that you have not connected an actuator directly to the main control board.
2. Check the connections between the actuator and the ionizer, as well as between the ionizer and the main control board.

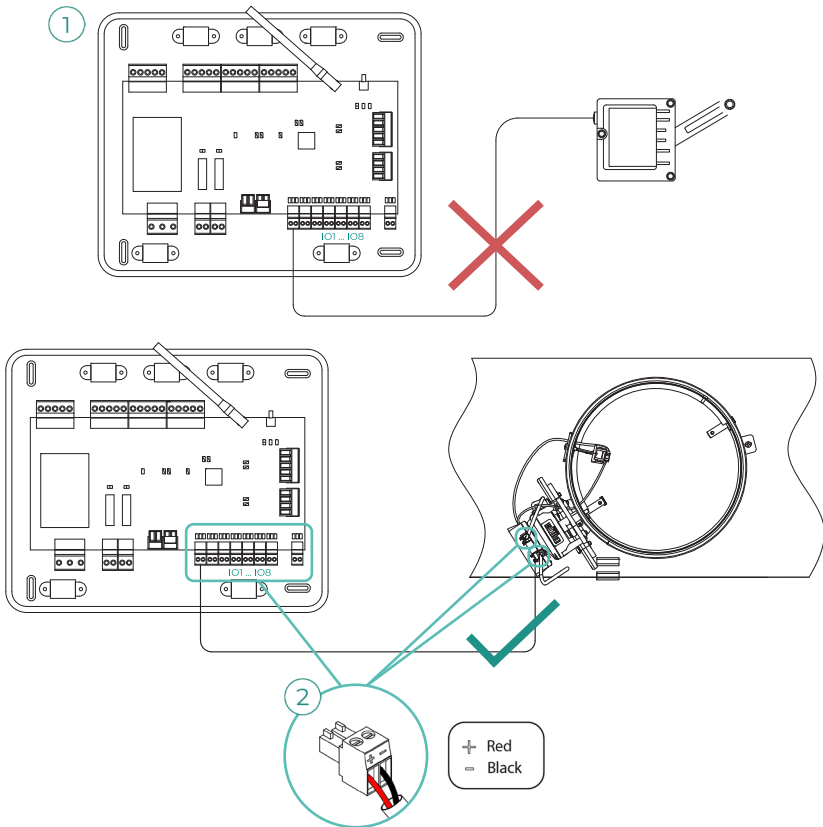

Error IAQ7. Loss of communication between the AirQ Sensor and the main control board

This issue does not allow the system to control the device. To resolve this issue, make the following checks:

1. AirQ Sensor and main control board status: Correct operation of the CAN bus LED.
2. Connection: Check that the polarity of the connections to the main control board and the AirQ Sensor is correct.

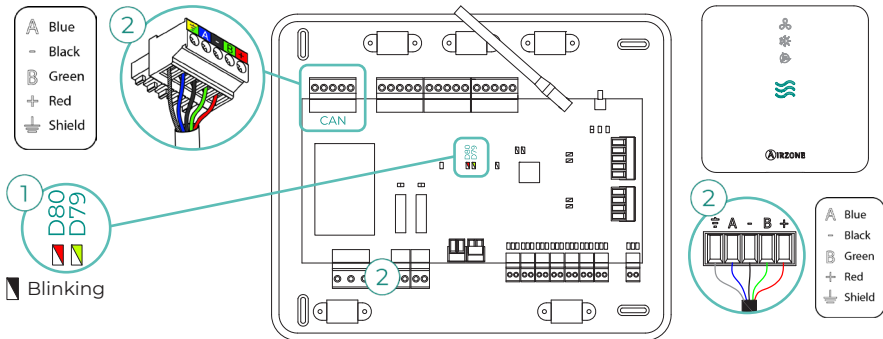

AC unit error. Anomaly in the AC unit

Consult the type of incident on the AC unit's thermostat and perform the repair actions indicated by the manufacturer.

AC unit error. Refrigerant leakage

This incident indicates that the existence of a refrigerant gas leak in the indoor unit controlled by the system has been confirmed (in the case of a VRF system, the warning will also be given).

The Airzone system will give control to the indoor unit, so control of the air stage will be lost momentarily. Neither the radiant stage nor CCP production will be affected by the blocking.

To exit this leakage error protection mode, the incident on the indoor unit must first be resolved. Once the error disappears, control of the system will be restored.

Navigation trees

AIRZONE BLUEFACE ZERO

Screensaver

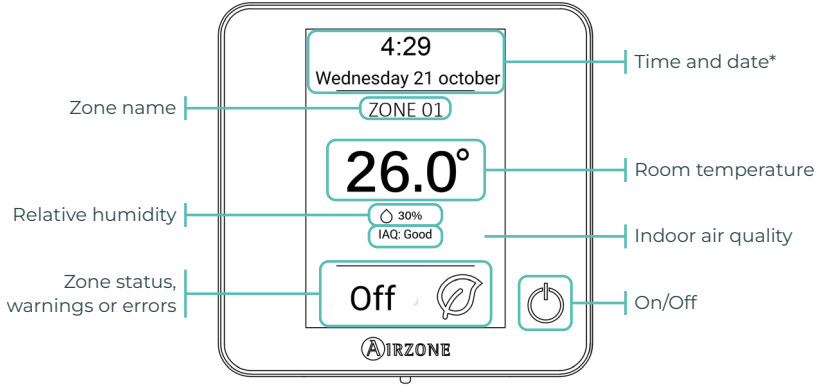

**Note: If the system has Webserver, weather information will also appear.*

Main screen

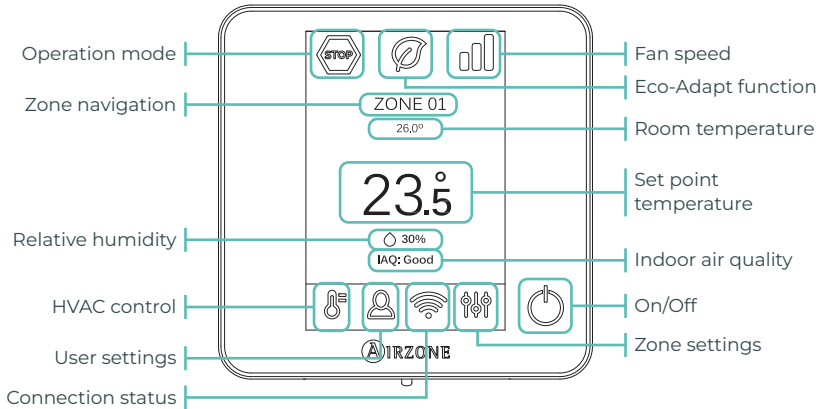

Screensaver

- Time and date*
- Current zone
- Room temp.*
- Relative humidity*
- Zone status
- Weather information

*Configurable values

Touch any place on the screen

Main screen

Operation mode	ECO-Adapt	Fan speed	Current zone	Relative humidity
<ul style="list-style-type: none"> Cooling Heating Dry** Ventilation** Stop 	<ul style="list-style-type: none"> Off A A+ A++ 	<ul style="list-style-type: none"> Automatic High Medium Low 	<p>Room temp.</p> <hr/> <p>Set point temp.</p> <p>+ Temperature</p> <p>- Temperature</p>	<p>Indoor air quality</p>
<p>HVAC control</p> <hr/> <p>User settings</p> <ul style="list-style-type: none"> Lang./Country Brightness Information <hr/> <p>ON / OFF</p>	<p>Connection status</p> <ul style="list-style-type: none"> Connected to Internet (Wi-Fi) No Internet connection (Wi-Fi) Not connected to the network Connected to Internet (Ethernet) No Internet connection (Ethernet) 	<p>Zone settings</p> <ul style="list-style-type: none"> Sleep mode Anti-freezing Grille angle** Control stages** Q-Adapt Lite settings Purification 		

Press and hold on the zone settings icon

Advanced settings

Zone	System
Thermostat settings	System address**
Control stages**	Radio channel
Use mode	Reset system
Offset	Centralized control
Reset thermostat	Reset Webserver
	Relays settings
	Basic mode config.

**Available in function of the installation type and the system settings.

AIRZONE THINK

Screensaver

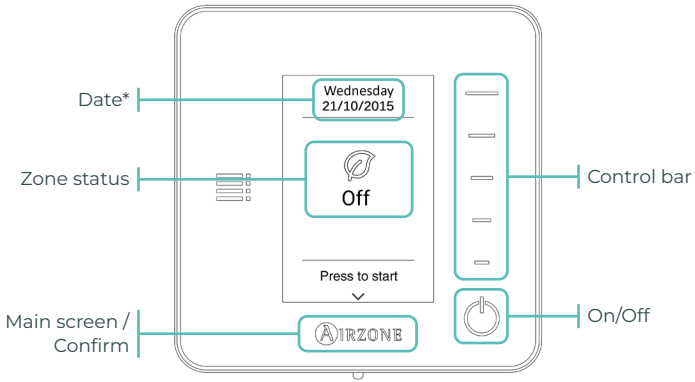

**Note: If the system has Webserver, weather information will also appear.*

Main screen

Access the main screen by pressing from the screensaver:

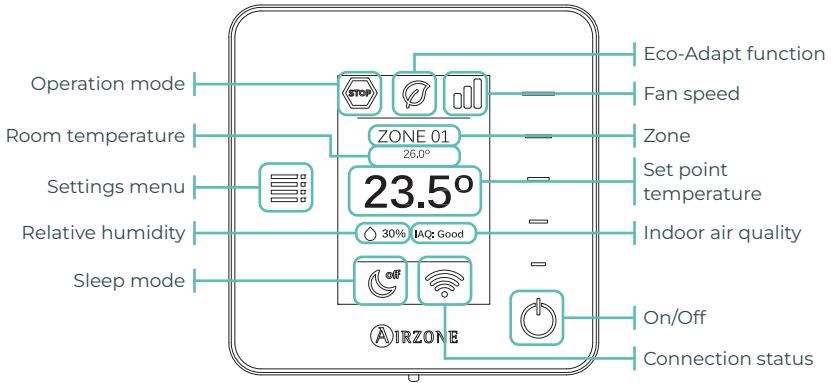

Screensaver

- Date*
- Current zone*
- Zone status
- Weather information*
- Airzone

*Depending on the devices connected

Press on 

Main screen

Informative icons

Operation mode

-  Cooling
-  Heating
-  Dry**
-  Ventilation**
-  Stop

ECO-Adapt

-  Off
-  A
-  A+
-  A++

Fan speed

-  Automatic
-  High
-  Medium
-  Low

Current zone

Relative humidity





Room temp.

Indoor air quality

Set point temp.

Sleep mode

Connection status

-  Connected to Internet (Wi-Fi)
-  No Internet connection (Wi-Fi)
-  Not connected to the network
-  Connected to Internet (Ethernet)
-  No Internet connection (Ethernet)

Capacitive buttons

Settings menu

- Mode**
- Speed
- Sleep mode
- Zone navigation
- Purification

Control bar

ON / OFF

Airzone

Press and hold twice on 

Advanced settings

Zone

- Thermostat settings
- Use mode
- Control stages**
- Offset
- Reset thermostat

System

- System address**
- Temperature range
- Combined stage**
- Type of opening
- Q-Adapt
- Relays settings
- Centralized control
- Return temperature
- Radio channel
- Information
- Reset Webserver

**Available in function of the installation type and the system settings.



airzonecontrol.com

Marie Curie, 21
29590 Málaga
Spain

v 100