

## ES AIRQ SENSOR DE CALIDAD AIRE INTERIOR CAI

Interfaz para el control y monitorización de la calidad del aire de una zona en un sistema Airzone. Acabado en acero y cristal.

Funcionalidades:

- Indicador del estado de la calidad del aire: Buena (verde), Media (amarillo) y Baja (rojo).
- Lectura de humedad relativa, CO2, PM 2.5 y 10 y TVOC de la zona.
- Gestión de ventilación mecánica controlada a través de señal 0-10V o on/off remoto.
- Funcionamiento con Aidoo Pro / AZCE8CBxMOT / AZCE8CBxDIN / AZPV8CB1IAQ y la APP Airzone Cloud (Android / iOS).

## FR CAPTEUR DE QUALITÉ DE L'AIR INTÉRIEUR AIRQ

Interface de contrôle et de surveillance de la qualité de l'air d'une zone dans un système Airzone. Finition en acier et verre.

Fonctionnalités:

- Indicateur de l'état de la qualité de l'air: Bonne (vert), Moyenne (jaune) et Faible (rouge).
- Mesure de l'humidité relative, du CO2, des PM 2,5 et 10, et des COVT de la zone.
- Gestion de la ventilation mécanique contrôlée via un signal 0-10V ou marche/arrêt à distance.
- Peut fonctionner avec Aidoo Pro / AZCE8CBxMOT / AZCE8CBxDIN / AZPV8CB1IAQ et l'application Airzone Cloud (Android / iOS).

## EN AIRQ INDOOR AIR QUALITY SENSOR

Interface for controlling and monitoring air quality in a zone in an Airzone system. Finished in steel and glass.

Functionalities:

- Air quality status indicator: Good (green), Medium (yellow), and Low (red).
- Readings of relative humidity, CO2, PM 2.5 and 10, and TVOC in the zone.
- Management of controlled mechanical ventilation through 0-10V signal or remote on/off.
- Can operate with Aidoo Pro / AZCE8CBxMOT / AZCE8CBxDIN / AZPV8CB1IAQ and the Airzone Cloud app (Android / iOS).

## IT SENSORE DI QUALITÀ DELL'ARIA AIRQ

Interfaccia per il controllo e il monitoraggio della qualità dell'aria in una zona all'interno di un sistema Airzone. Finitura in acciaio e vetro.

Funzionalità:

- Indicatore dello stato della qualità dell'aria: Buono (verde), Medio (giallo) e Basso (rosso).
- Lettura dell'umidità relativa, del CO2, dei PM 2.5 e 10 e del TVOC nella zona.
- Gestione della ventilazione meccanica controllata tramite segnale 0-10V o attivazione/spegnimento remoto.
- Può con Aidoo Pro / AZCE8CBxMOT / AZCE8CBxDIN / AZPV8CB1IAQ e l'app Airzone Cloud (Android / iOS).

## PT SENSOR DE QUALIDADE DO AR INTERNO AIRQ

Interface para controle e monitoramento da qualidade do ar de uma zona em um sistema Airzone. Acabamento em aço e vidro.

Funcionalidades:

- Indicador do estado da qualidade do ar: Bom (verde), Médio (amarelo) e Baixo (vermelho).
- Leitura de umidade relativa, CO2, PM 2.5 e 10 e TVOC na zona.
- Gestão de ventilação mecânica controlada por sinal 0-10V ou on/off remoto.
- Pode operar com Aidoo Pro / AZCE8CBxMOT / AZCE8CBxDIN / AZPV8CB1IAQ e o aplicativo Airzone Cloud (Android / iOS).

## DE AIRQ RAUMLUFTQUALITÄTSFÜHLER

Schnittstelle zur Steuerung und Überwachung der Luftqualität in einer Zone in einem Airzone-System. Ausführung in Stahl und Glas.

Funktionalitäten:

- Anzeige des Luftqualitätsstatus: Gut (grün), Mittel (gelb) und Niedrig (rot).
- Messung der relativen Luftfeuchtigkeit, CO2, PM 2,5 und 10 sowie TVOC in der Zone.
- Verwaltung der kontrollierten mechanischen Lüftung über ein 0-10V-Signal oder eine Fernbedienung.
- Kann a mit Aidoo Pro / AZCE8CBxMOT / AZCE8CBxDIN / AZPV8CB1IAQ und der Airzone Cloud-App (Android / iOS) betrieben werden.

AZX6AIQNSB

AZX6AIQNS

# AIRZONE



ES EN PT FR IT DE

## (ES) CARACTERÍSTICAS TÉCNICAS (EN) TECHNICAL SPECS (PT) CARACTERÍSTICAS TÉCNICAS

Alimentación y consumo / Power supply and consumption / Alimentação e consumo	
V máx.	12 VDC
I máx.	750mA
Consumo Stand-by / Stand-by consumption / Consumo em stand-by	1,4 W
Medidas del sensor / sensor measurements / medidas do sensor	
Humedad Relativa	0 ... 100%
CO2	0 ... 2000 ppm
PM2.5	0 ... 62 µg/m3
PM10	0 ... 300 µg/m3
TVOC	0 ... 800 ppb
CAN	
Cable apantallado y trenzado / Shielded twisted pair / Cabo blindado e trançado	2 x 0,22 + 2 x 0,5 mm <sup>2</sup>
V máx	12 V
RS485	
Cable apantallado y trenzado / Shielded twisted pair / Cabo blindado e trançado	2 x 0,22 + 2 x 0,5 mm <sup>2</sup>
V máx	12 V
Protocolo de comunicaciones / Communications protocol / Protocolo de comunicação	MODBUS RS-485 Par - 19200 bps
Damper	
Nº de motores máximo/Maximum number of engines/Nº máximo de motores	1
V máx.	12 VDC
I máx.	120 mA
0-10 V	
V mín.	1 VDC
V máx.	10 VDC
Relay	
V max	30 VDC
I max	1 A
Temperaturas y humedades operativas / Operating temperatures and humidities / Temperaturas e umidades de operação	
Almacenaje / Storage / Armazenamento	-20 ... 70 °C
Funcionamiento / Operation / Funcionamento	0 ... 50 °C
Humedad relativa / Relative humidity / Humidade relativa	Max 80%: 0 ... 31 °C / Min 50%: 40 °C / Min 40%: 50 °C
Aspectos mecánicos / Mechanical aspects / Aspectos mecânicos	
Grado de protección / Protection class / Grau de proteção	IP 20
Peso / Weight / Peso	242 g

## (FR) CARACTÉRISTIQUES TECHNIQUES (IT) CARATTERISTICHE TECNICHE (DE) TECHNISCHE DATEN

Alimentation et consommation / Alimentazione e consumo / Stromversorgung und Verbrauch	
V máx.	12 VDC
I máx.	750mA
Cosommation Stand-by / Consumo Stand-by / Stand-by-Leistungsaufnahme	1,4 W
Mesures du capteur / misura del sensore / Sensormessungen	
Humedad Relativa	0 ... 100%
CO2	0 ... 2000 ppm
PM2.5	0 ... 62 µg/m3
PM10	0 ... 300 µg/m3
TVOC	0 ... 800 ppb
CAN	
Câble torsadé et blindé / Cavo schermato / Abgeschirmtes Kabel und umflochten	2 x 0,22 + 2 x 0,5 mm <sup>2</sup>
V máx	12 V
RS485	
Câble torsadé et blindé / Cavo schermato / Abgeschirmtes Kabel und umflochten	2 x 0,22 + 2 x 0,5 mm <sup>2</sup>
V máx	12 V
Damper	
Nombre maximal de moteurs/Numero massimo di motori/ Maximale Anzahl von Motoren	1
V máx.	12 VDC
I máx.	120 mA
0-10 V	
V mín.	1 VDC
V máx.	10 VDC
Relay	
V max	30 VDC
I max	1 A
Températures opérative / Temperature operative / Betriebstemperaturen	
De stockage / Stoccaggio / Lagerung	-20 ... 70 °C
De fonctionnement / Funzionamento / Betrieb	0 ... 50 °C
Humidité relative / Umidità relativa / Relative Luftfeuchtigkeit	Max 80%: 0 ... 31 °C / Min 50%: 40 °C / Min 40%: 50 °C
Aspects mécaniques / Aspetti meccanici / Mechanische Aspekte	
Degré de protection / Grado di protezione / Schutzklasse	IP 20
Poids / Peso / Gewicht	242 g

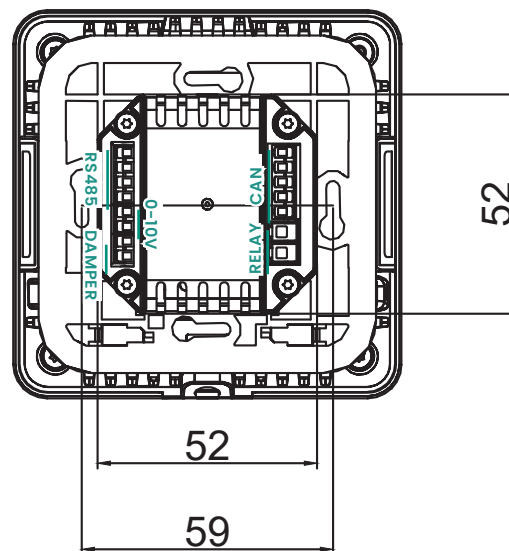
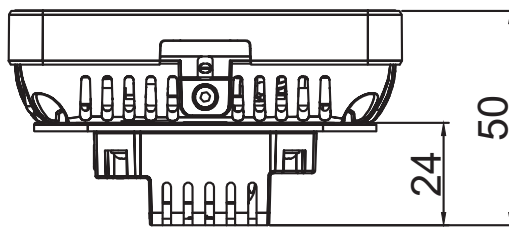
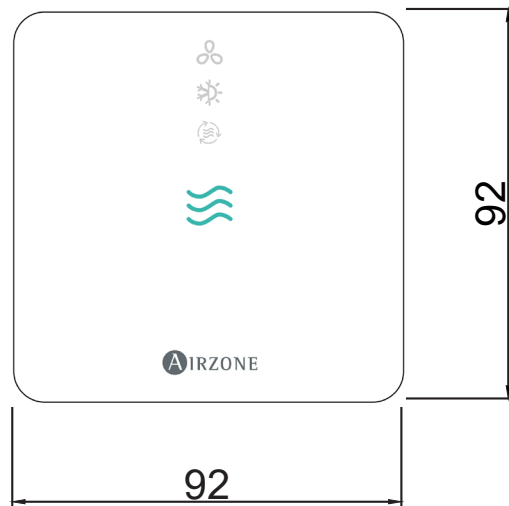

airzonecontrol.com

Marie Curie, 21  
29590 Málaga  
Spain





1

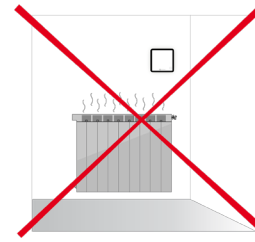
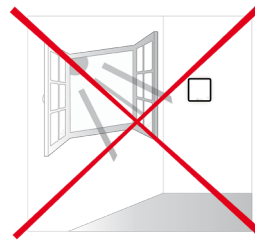
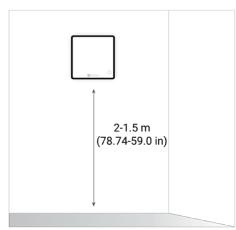

(ES) La altura del dispositivo no debe ser superior a 2 m con respecto del suelo. La ubicación de este dispositivo en viviendas debe ser en estancias de día o tránsito (p.e pasillo).

(EN) The height of this device in homes should be in day rooms or transit areas (e.g., hallway).

(PT) A altura do dispositivo não deve ser superior a 2 metros do chão. A localização deste dispositivo em residências deve ser em salas de estar ou áreas de trânsito (por exemplo, corredor).

(FR) La distance entre l'appareil et le sol ne doit pas excéder 2 mètres. L'emplacement de cet appareil dans les habitations doit être dans les pièces de jour ou les zones de passage (par exemple, couloir).

(IT) L'altezza del dispositivo non deve superare i 2 m dal pavimento. La posizione di questo dispositivo nelle abitazioni deve essere in ambienti diurni o aree di transito (ad esempio, corridoio).

(DE) Die Höhe des Geräts darf nicht mehr als 2 m über dem Boden liegen. Der Standort dieses Geräts in Wohnräumen sollte sich in Aufenthaltsräumen oder Durchgangsbereichen befinden (z. B. Flur).

2

2.1.

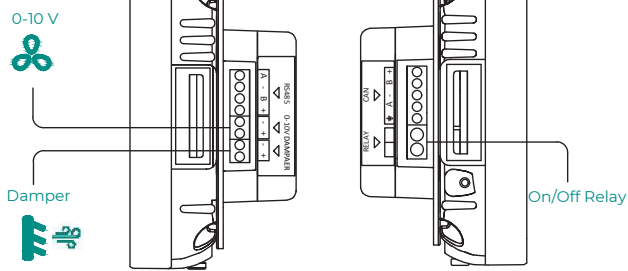

2.a.



2.b.

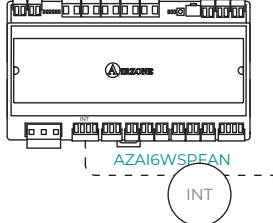

2.c.

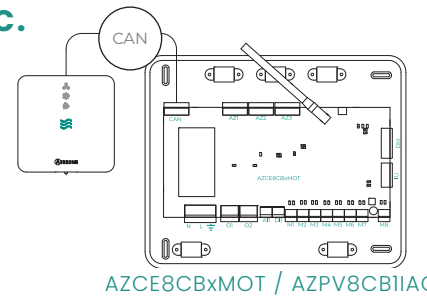

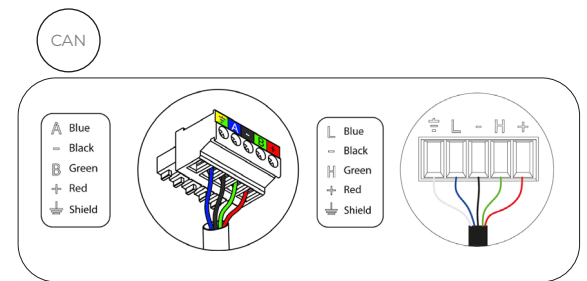
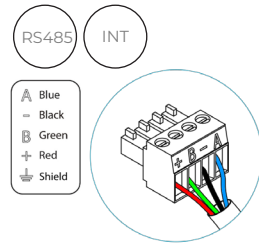
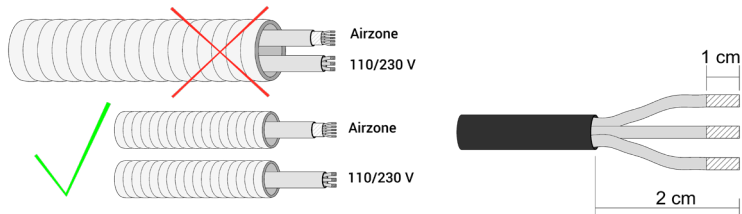
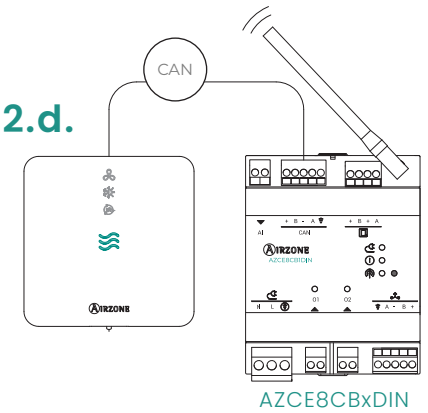

2.d.

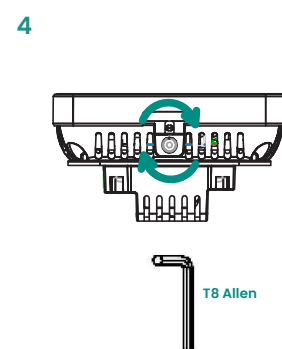
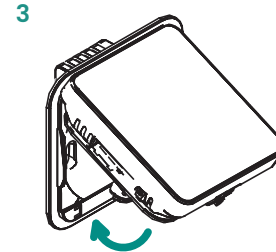
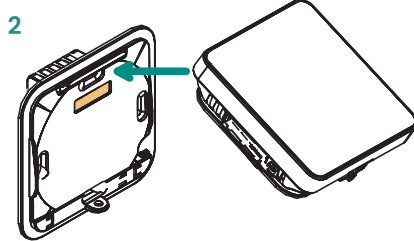
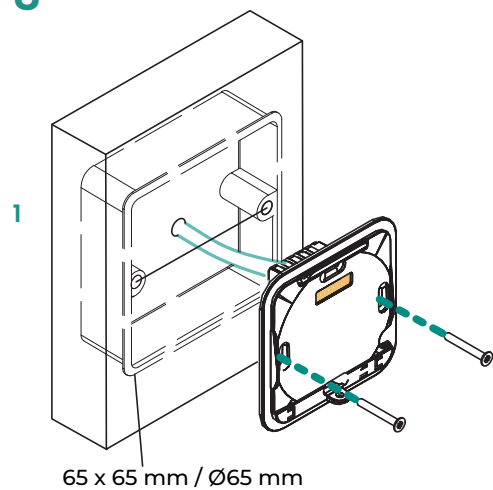

3



65 x 65 mm / Ø65 mm

1	Ventilación VMC / ventilation CMV / ventilação VMC		
	Modo frío-calor / cool-heat mode / modo frio-aquecimento		
2	Ventilación / ventilation / ventilação		
	Seco / Dry / Seco		
3	Ionización / ionization / ionização		
	Indicador de calidad de aire / Air quality indicator / Indicador de qualidade do ar		
	Buena / good / boa	media / medium / média	baja / low / baixa
4	Verde / green / verde	amarillo / yellow / amarelo	rojo / red / vermelho
			



1	Ventilation VMC / ventilazione VMC / Belüftung KW		
	Mode froid-chaud / modalità freddo-calore / Kühl-Heizmodus		
2	Ventilation / ventilazione / Belüftung		
	Sec / Secco / Trocken		
3	Ionisation / ionizzazione / Ionisierung		
	Indicateur de qualité de l'air / Indicatore di qualità dell'aria / Luftqualitätsindikator		
	Bonne / buona / gut	moyenne / media / Medium	basse / bassa / niedrig
4	Vert / verde / grün	jaune / giallo / gelb	rouge / rosso / rot
	