

Airzone VAF Zoning System: Elements & Connection Cheat Sheet

-  Control of individual units
-  Underfloor heating control
-  Heating & Cooling
-  Up to 10 zones
-  Residential & Commercial

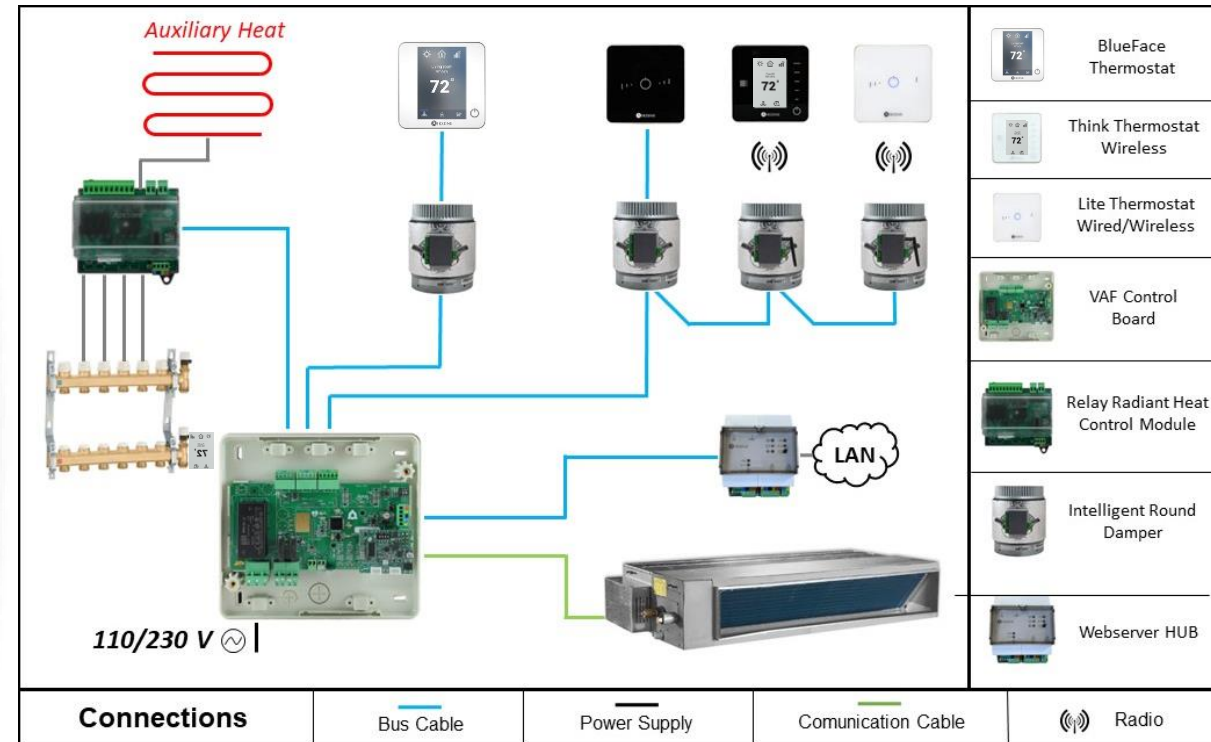

Specification

- Check Indoor Unit compatibility [here](#)

- If there is Integration:

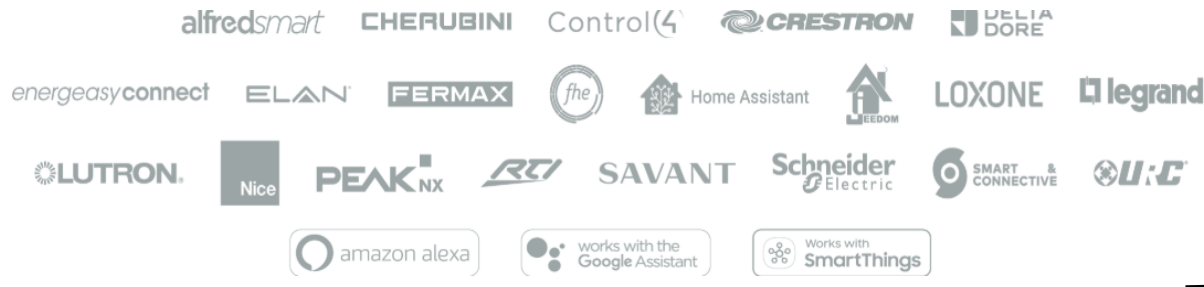

Webserver HUB (AZX6WSPHUB) is required

- Individual (ductless) or Zoned Indoor Unit:

Zoned IDU -> as many thermostats as zones with their motorized dampers

Individual IDU -> as many thermostats as zones with their Airzone zone module for individual equipment

- Underfloor Heating, Infloor Heating, Baseboard Heating, Duct Heater, Supplemental Heater, or Auxiliary Heat per zone -> Relay Radiant Heat Control Module (AZVAF5OUTPUTS) If there are zones with only underfloor heating -> then a thermostat and a radiant zone module (AZVAFZMRAD[C/R]) is required for each of these zones.

- Check Damper Selection [here](#)

Choose your thermostats [here](#)



Wiring Diagram

Available formats:

- [DWG](#)
- [PDF](#)



Wire for the whole system:
Airzone Shielded Bus Cable UL444
[AZX6CBLBUS300FT](#)

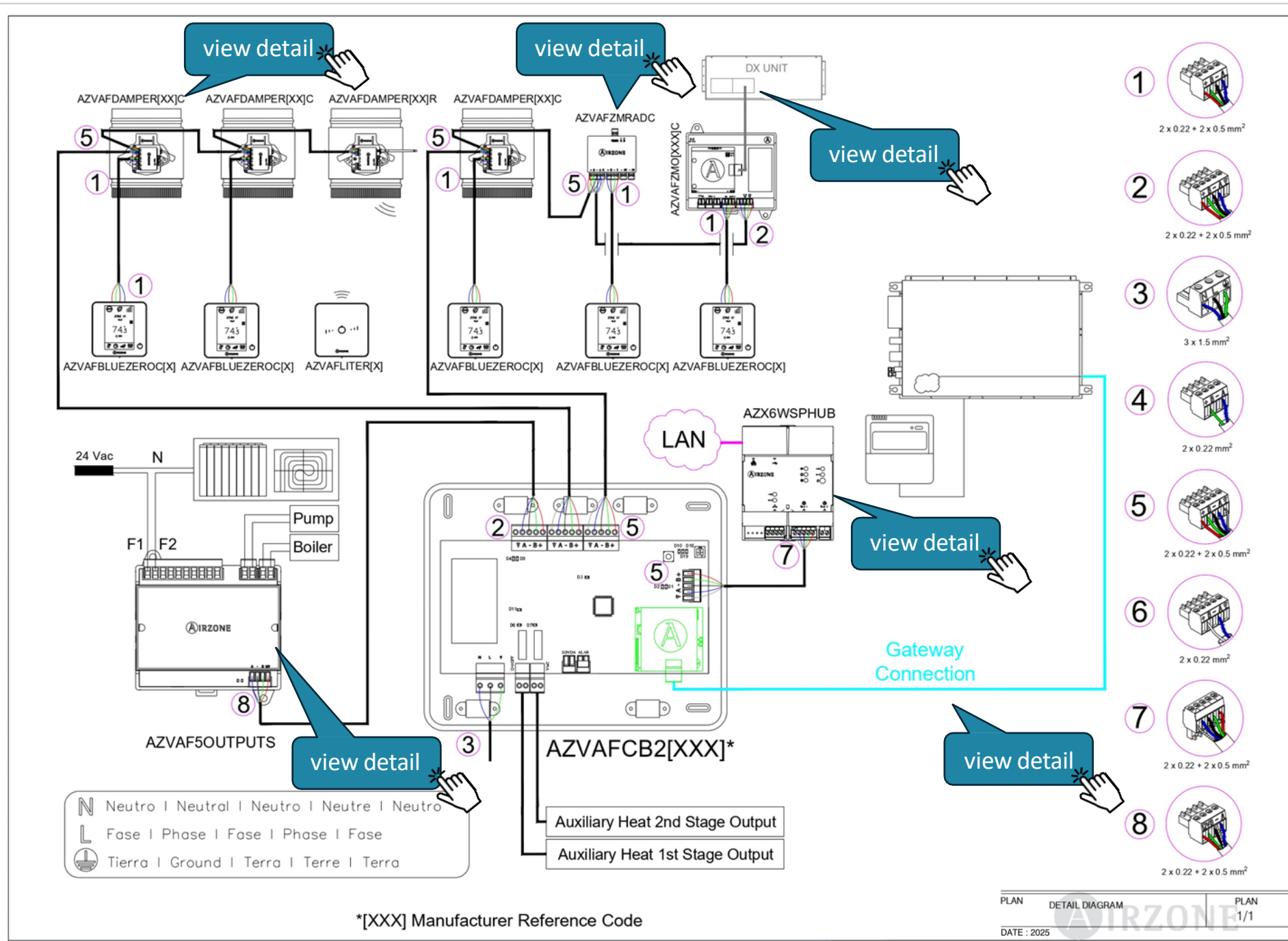
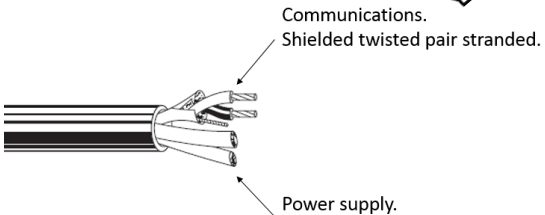

Control Board

AZVAFCBXH13



Documentation:

- [Data Sheet CB](#)
- [Data Sheet Gateway](#)
- [Manual](#)
- [Quick Installation Guide](#)



Wire for the whole system:

Airzone Shielded Bus Cable UL444

[AZX6CBLBUS300FT](#)

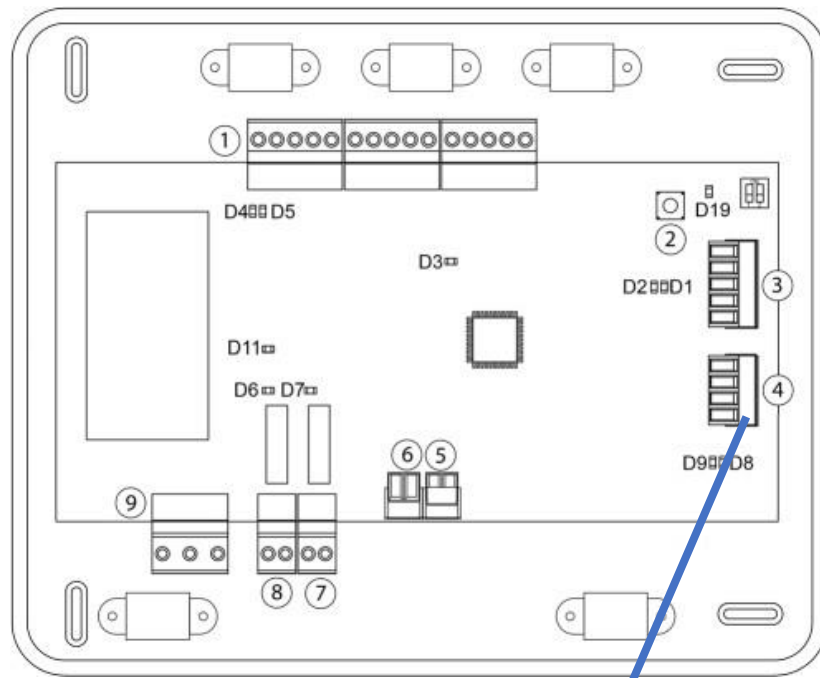
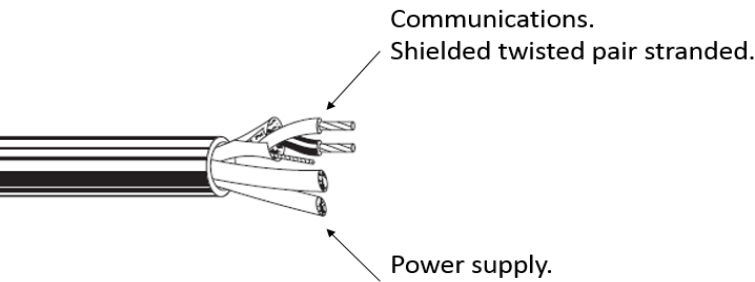

N°	Description / Description / Descripción
1	Airzone connection bus / Bus de connexion Airzone / Bus de conexión Airzone
2	SW1
3	Automation bus / Bus domotique / Bus domótico
4	AC unit bus / Bus du gainable / Bus máquina
5	Alarm input (normally close) / Entrée alarme (normalement fermé) / Entrada alarma (normalmente cerrada)
6	Protection temperature probe / Sonde température protection / Sonda temperatura protección
7	Auxiliary heat 2nd Stage output / Sortie de l'étape 2 du chauffage auxiliaire / Salida de 2ª etapa de calor auxiliar
8	Auxiliary heat 1st Stage output / Sortie de l'étape 1 du chauffage auxiliaire / Salida de 1ª etapa de calor auxiliar
9	Power supply / Alimentation / Alimentación

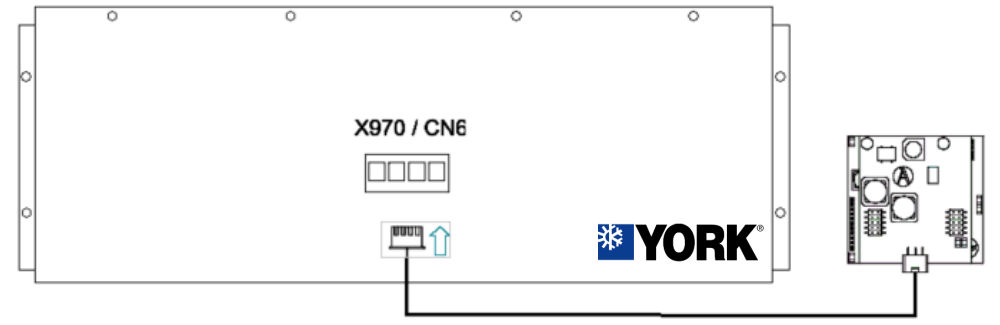
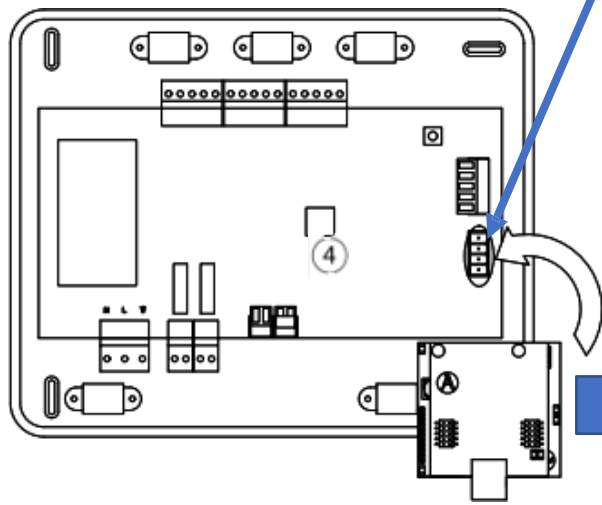

Return to Wiring diagram



AZVAFZMOHI3R / AZVAFZMOHI3C

Zone module for IDU

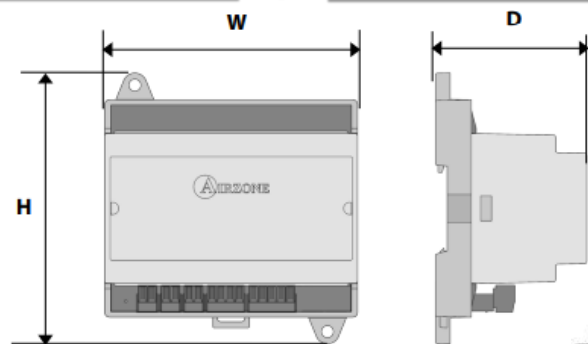

Mechanical aspects / Aspects mécaniques / Aspectos mecánicos	
Assembly / Montage / Montaje	On DIN rail or on wall Sur rail DIN ou en saillie En carril DIN o superficie
Size / Dimensions / Dimensiones (WxHxD)	105x112x62.8 mm (4.13x4.41x2.47)
In DIN units / En unités DIN / En unidades DIN	6

Documentation:

- [Data Sheet](#)
- [Gateway](#) 
- [Manual](#)

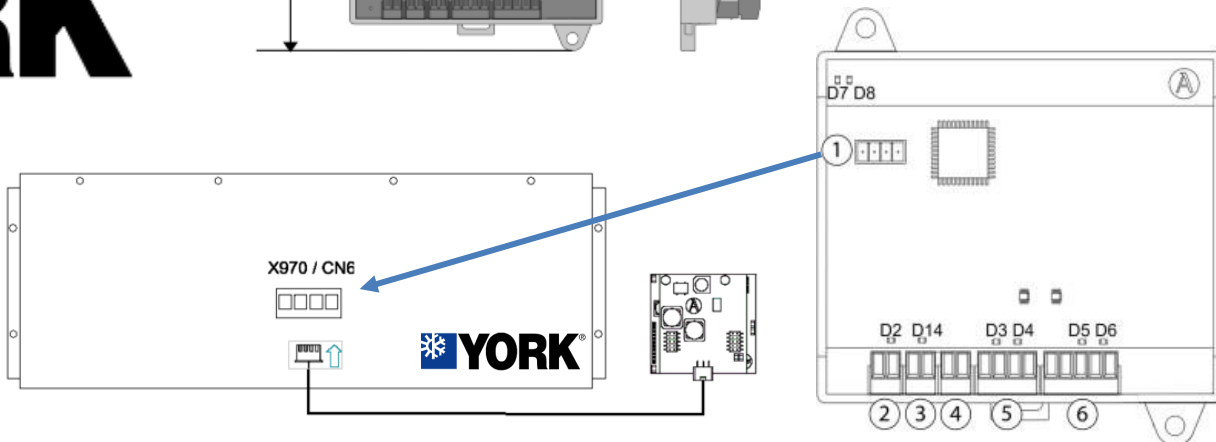

Meaning / Signification / Significado	
①	Gateway connection / Connexion passerelle / Conexión pasarela
②	Probe input / Entrée sonde / Entrada sonda
③	Window contact / Contact de fenêtre / Contacto ventana
④	Presence contact / Détecteur de présence / Contacto presencia
⑤	Thermostat connection / Connexion thermostat / Conexión termostato
⑥	Airzone connection bus / Bus de connexion Airzone / Bus de conexión Airzone

Note: Use a shielded twisted pair to connect the window contact.
Note: Utiliser un câble blindé pour la connexion du contact de fenêtre.
Nota: Para la conexión del contacto ventana utilizar cable apantallado.

Wire for the whole system:

Airzone Shielded Bus Cable UL444

[AZX6CBLBUS300FT](#) 

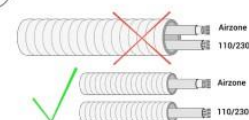
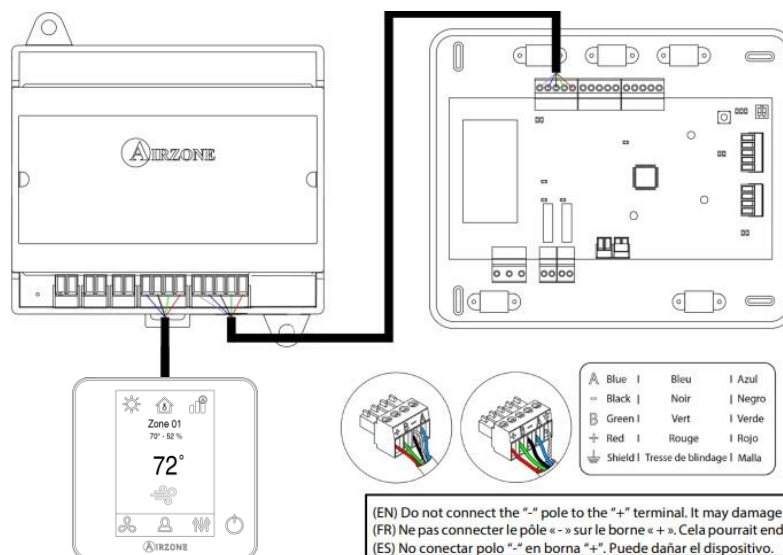
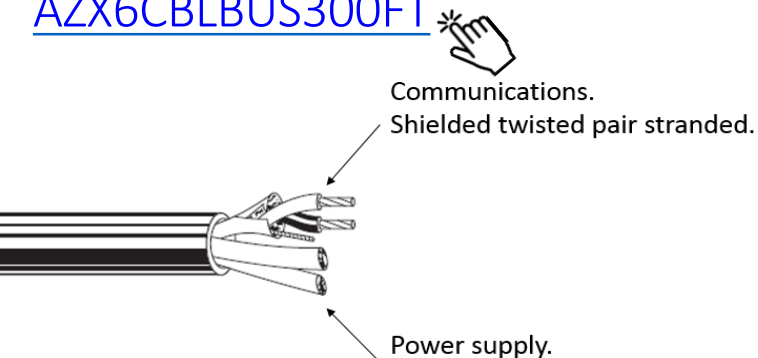

(EN) Do not connect the "-" pole to the "+" terminal. It may damage the device.
 (FR) Ne pas connecter le pôle « - » sur le borne « + ». Cela pourrait endommager le dispositif.
 (ES) No conectar polo "-" en borna "+". Puede dañar el dispositivo.

Return to Wiring diagram 



Relay Radiant Heat Control Module

Optional element – review the [Specification](#)

AZVAF5OUTPUTS

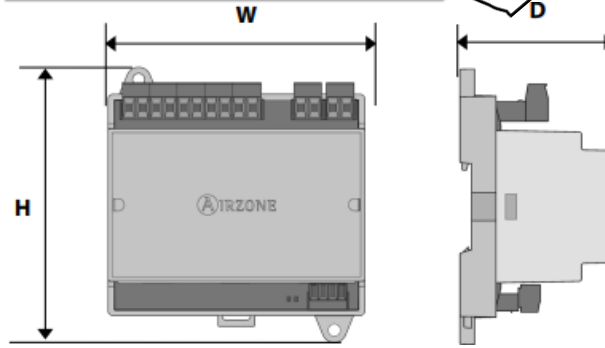

Power supply and consumption / Alimentación y consumo	
Type of power supply / Type d'alimentation / Tipo de alimentación	Vdc
	V max 12 V
	I max 160 mA
Stand-by consumption / Consumption Stand-by / Consumo Stand-by	4 W
Connection and communications / Conexión y comunicaciones	
Type of cable / Type de câble / Tipo de cable	Shielded twisted pair Torsadé et blindé Trenzado y apantallado
Communication wires / Fils de communications / Hilos de comunicación	2 x 0,22 mm ² (AWG 23 – 2 wired)
Power supply wires / Fils d'alimentation / Hilos de alimentación	2 x 0,5 mm ² (AWG 20 – 2 wired)
Maximum distance / Distance maximum / Distancia máxima	100 m (328 ft)
Activation relays / Relais d'activation / Relés de activación	
N° of outputs / Nombre de sorties / N° de salidas	7
	V max 24 V
	I max 1 A cos θ ($\theta > 0,6$)
Mechanical aspects / Aspects mécaniques / Aspectos mecánicos	
Assembly / Montage / Montaje	On DIN rail Sur rail DIN Sobre carril DIN
Dimensions / Dimensions / Dimensiones (WxHxD)	105x112x62.8 mm (4.1x4.4x2.5")
In DIN units / En unités DIN / En unidades DIN	6

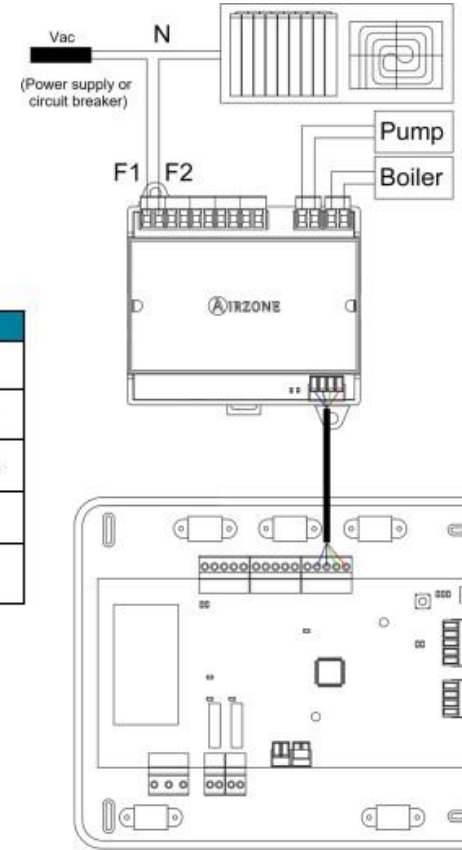

Documentation:

- [Data Sheet](#)
- [Manual](#)

Wire for the whole system:

Airzone Shielded Bus Cable UL444
[AZX6CBLBUS300FT](#)

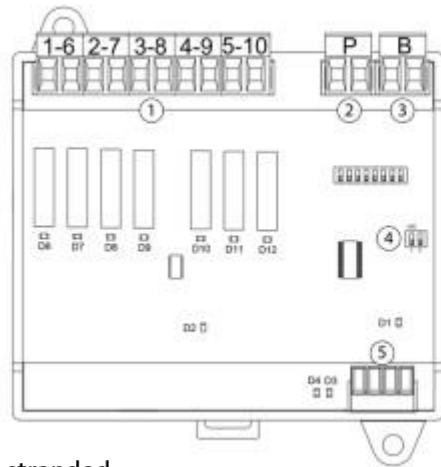

Communications.
Shielded twisted pair stranded.

Power supply.

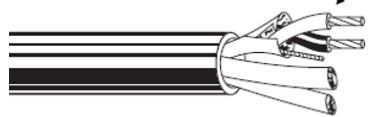

Meaning / Signification / Significado	
①	Zone control relays / Relais de contrôle des zones / Relés de zona
②	Pump control relay / Relais de contrôle de la pompe / Relés de bomba
③	Boiler control relay / Relais de contrôle de la chaudière / Relé de caldera
④	SW2
⑤	Airzone connection bus / Bus de connexion Airzone / Bus de conexión Airzone



Return to Wiring diagram



Radiant Zone Module

Optional - Only to use with radiant zones

AZVAFZMRADC

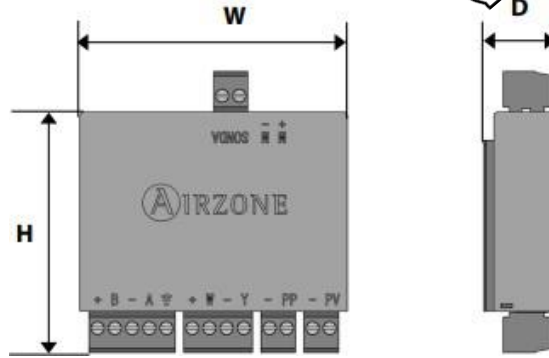

Actuator power supply / Alimentación del motor	
V max	±12 Vdc
I max	300 mA
Mechanical aspects / Aspects mécaniques / Aspectos mecánicos	
Dimensions / Dimensions / Dimensiones (WxHxD)	59x44,5x17mm (2.32x1.75x0.67")

Documentation:

- [Data Sheet](#)
- [Manual](#)

Wire for the whole system:

Airzone Shielded Bus Cable UL444

[AZX6CBLBUS300FT](#)

Communications.
Shielded twisted pair stranded.

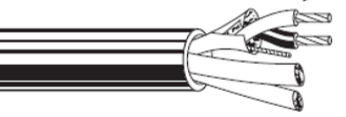

Power supply.

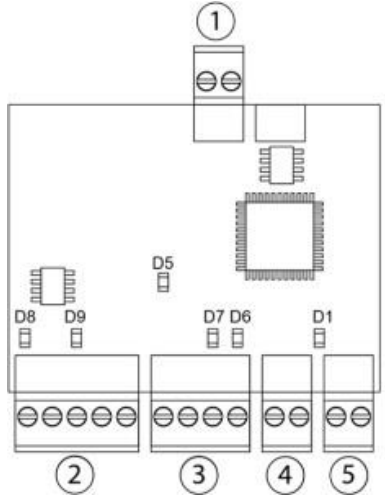

Meaning / Signification / Significado	
1	Probe connector / Connecteur sonde / Conector sonda
2	Airzone connection bus / Bus de connexion Airzone / Bus de conexión Airzone
3	Thermostat connection / Connexion thermostat / Conexión termostato
4	Presence contact / Détecteur de présence / Contacto presencia
5	Window contact / Contact de fenêtre / Contacto ventana

Note: Use a shielded twisted pair to connect the window contact.
Note: Utiliser un câble blindé pour la connexion du contact de fenêtre.
Nota: Para la conexión del contacto ventana utilizar cable apantallado.

(EN) Do not connect the "-" pole to the "+" terminal. It may damage the device.
 (FR) Ne pas connecter le pôle « - » sur le borne « + ». Cela pourrait endommager le dispositif.
 (ES) No conectar polo "-" en borna "+". Puede dañar el dispositivo.

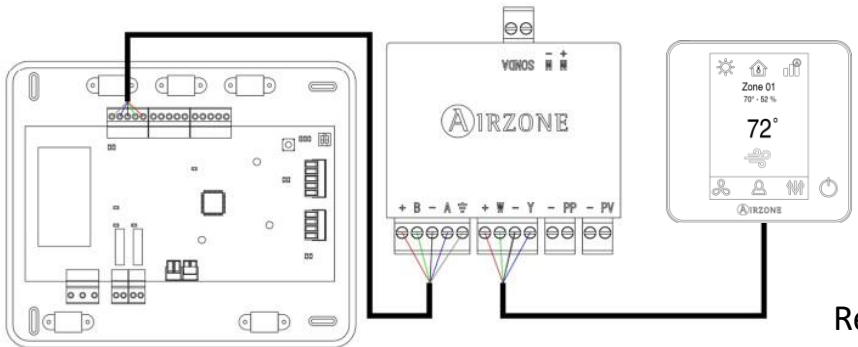
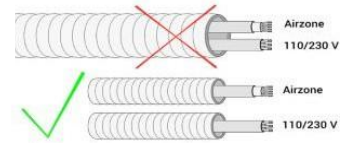

Return to Wiring diagram



Webserver HUB

AZX6WSPHUB

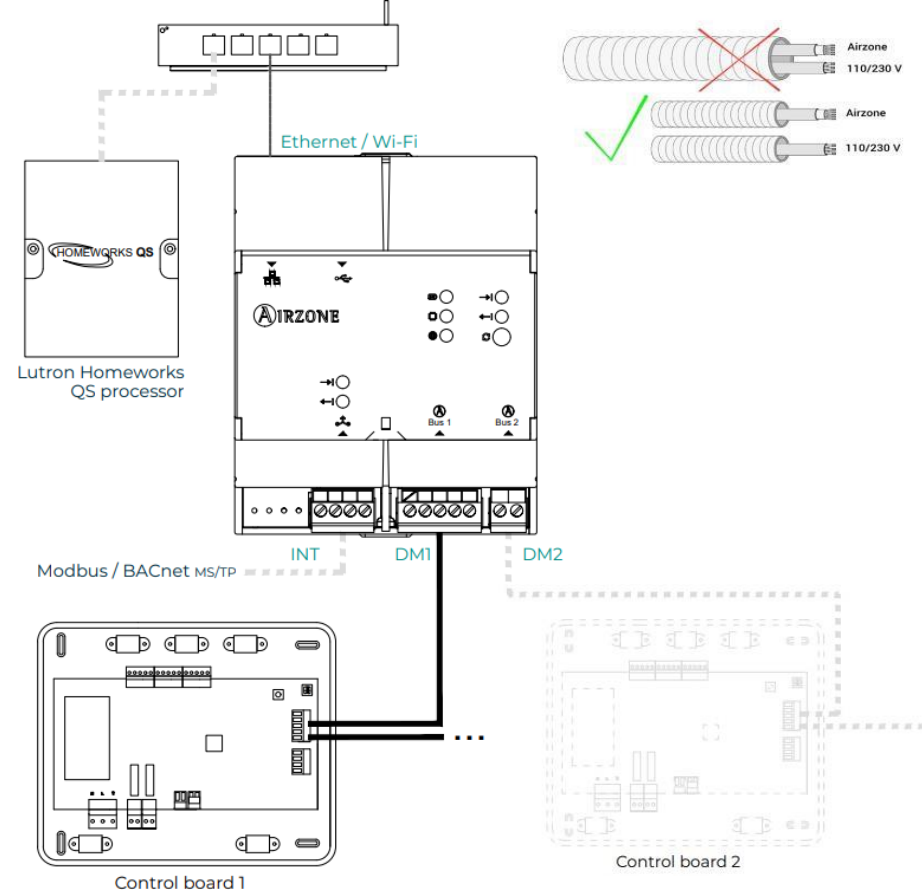
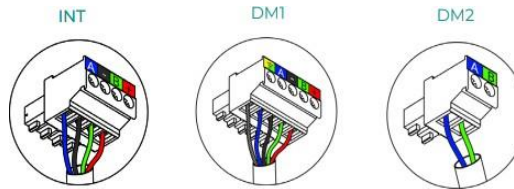
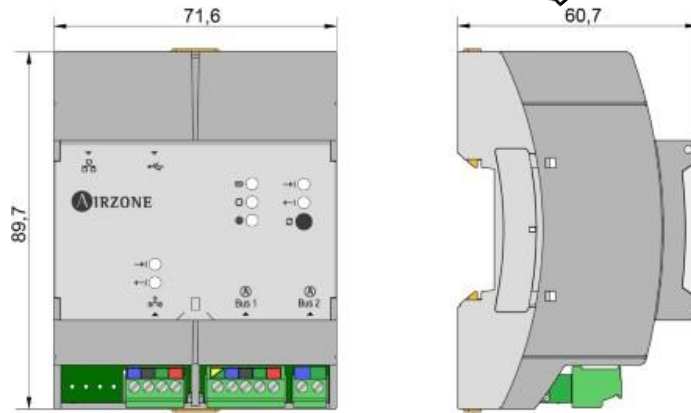

Documentation:

- [Data Sheet](#)
- [Manual](#)

Wire for the whole system:

Airzone Shielded Bus Cable UL444

[AZX6CBLBUS300FT](#)

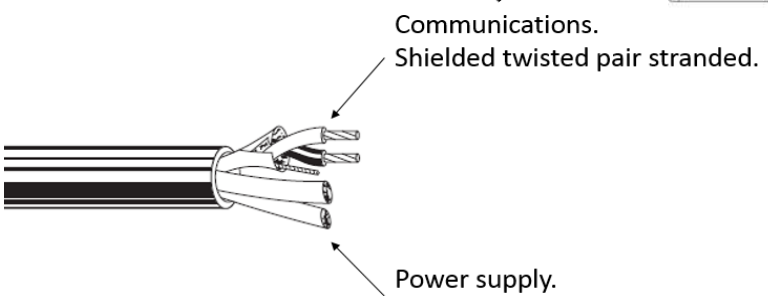

N°	Descripción / Description / Descrição
DM1 - DM2	Bus de conexión Airzone / Airzone connection bus / Barramento de conexão Airzone
INT	Puerto Modbus-BACnet / Modbus-BACnet port / Porta Modbus BACnet
Ethernet	Ethernet
x1	Detectar sistema / Detect system / Detectar sistema
	Reset

Webserver HUB integration:



Return to Wiring diagram



AZVAFDAMPER[XX]C / AZVAFDAMPER[XX]R

[XX] → dimensions in inches



C → wired

R → wireless

Dampers

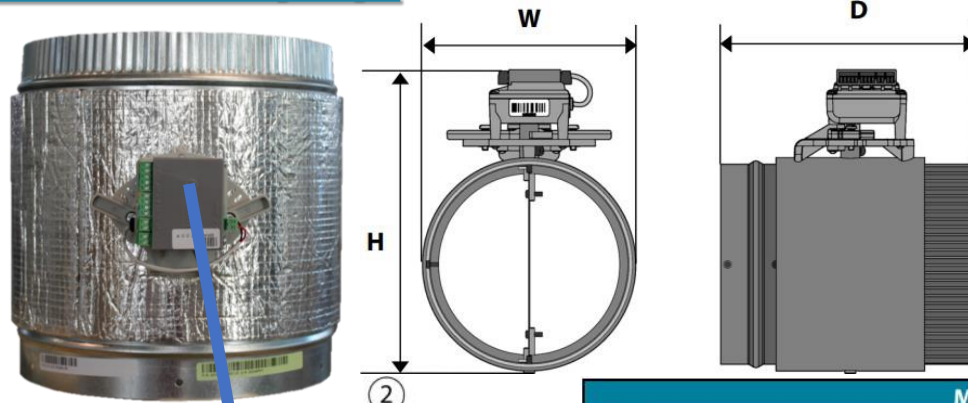

Damper with actuator / Registre motorisée / Compuerta motorizada

Power supply / Alimentation / Alimentación y consumo			
Type of power supply / Type d'alimentation / Tipo de alimentación		Vdc	12 V
		I max	250 mA
Mechanical aspects / Aspects mécaniques / Aspectos mecánicos			
Torque at the actuator axle / Couple au niveau de l'axe du moteur / Par en el eje motor			0.8 Nm
Size / Taille / Diámetro	Weight / Poids / Peso	Dimensions / Dimensions / Dimensiones (HxWxD)	
06"	0.755 kg (1.66 lb)	235.99x152.4x203.2 mm (9.3x6x8")	
08"	0.986 kg (2.17 lb)	271.45x203.2x215.9 mm (10.7x8x8.5")	
10"	1.961 kg (4.32 lb)	337.2x254x266.7 mm (13.3x10x10.5")	
12"	3.2 kg (7.05 lb)	388x304.8x419.1 mm (15.3x12x16.5")	
14"	4.5 kg (9.92 lb)	438.8x355.6x469.9 mm (17.3x14x18.5")	

Documentation:

- [Data Sheet](#)
- [Manual](#)

Selection of dampers

Quick guide for damper selection

Diameter	Max. Airflow (CFM)	
	Housing (1000 ft / min)	Offices (1200 ft / min)
6"	196	235
8"	349	419
10"	545	654
12"	785	942
14"	1069	1287

- Check Damper Selection [here](#)
- The dampers module come already mounted on dampers

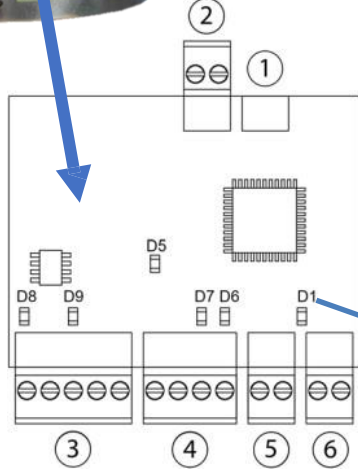

Meaning / Signification / Significado	
①	Motorized element connector / Connecteur élément motorisé / Conector elemento motorizado
②	Probe connector / Connecteur sonde / Conector sonda
③	Airzone connection bus / Bus de connexion Airzone / Bus de conexión Airzone
④	Thermostat connection / Connexion thermostat / Conexión termostato
⑤	Presence contact / Détecteur de présence / Contacto presencia
⑥	Window contact / Contact de fenêtre / Contacto ventana

Note: Use a shielded twisted pair to connect the window contact.
Note: Utiliser un câble blindé pour la connexion du contact de fenêtre.
Nota: Para la conexión del contacto ventana utilizar cable apantallado.

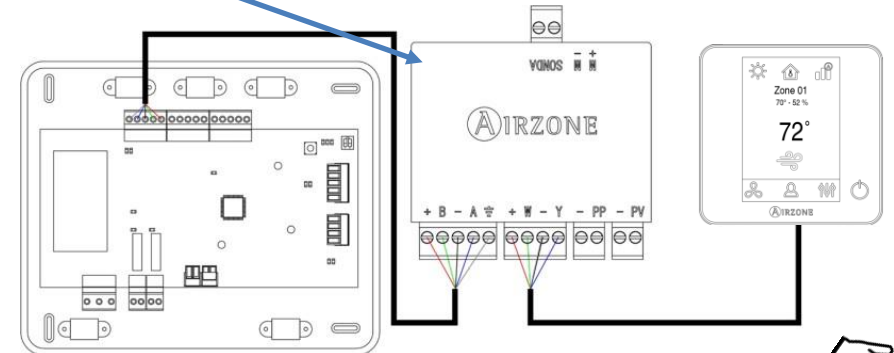

Return to Wiring diagram



FAQs

- Can I connect two or more dampers to a single thermostat?
Yes you can
- Can I not have a thermostat?
Yes, you can do a temp. sensor connected to the damper and control temperature via BlueZero thermostat or Airzone Cloud App
- Do I need the manufacturer thermostat connected?
Some manufacturers require the thermostat, check with your local salesperson to ask if you need it or not
- Can I use a rectangular damper from another manufacturer?
No, our system is closed and it will not work
- How many zones can I do?
Up to 10 zones either with dampers or individual units

Steps for subordinate damper:

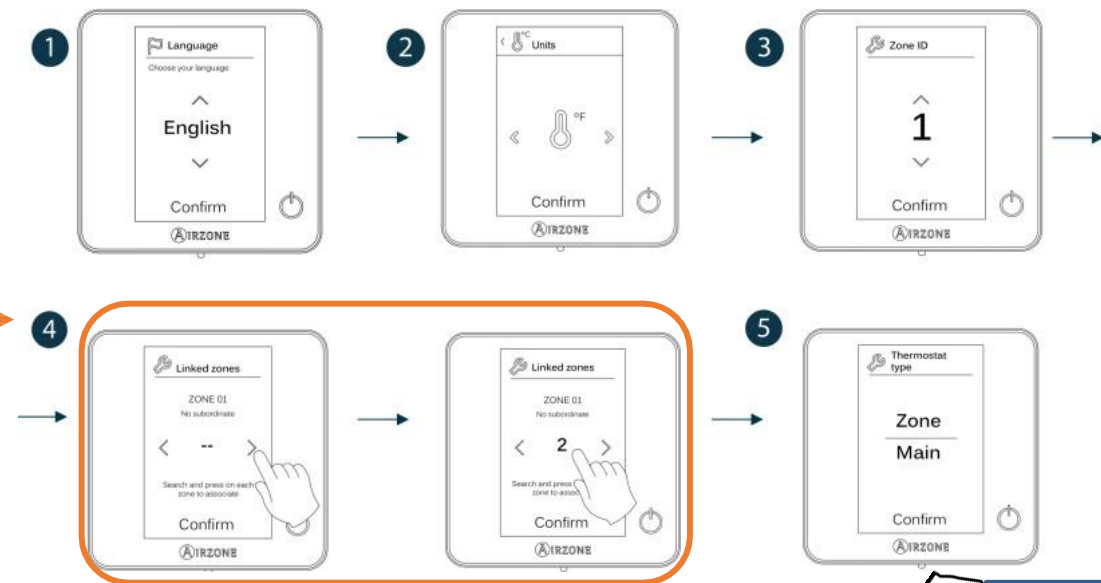

Return to Wiring diagram

